

Xerox Control Program-Five (CP-V)

Xerox 560 and Sigma 6/7/9 Computers

Remote Processing
Reference Manual

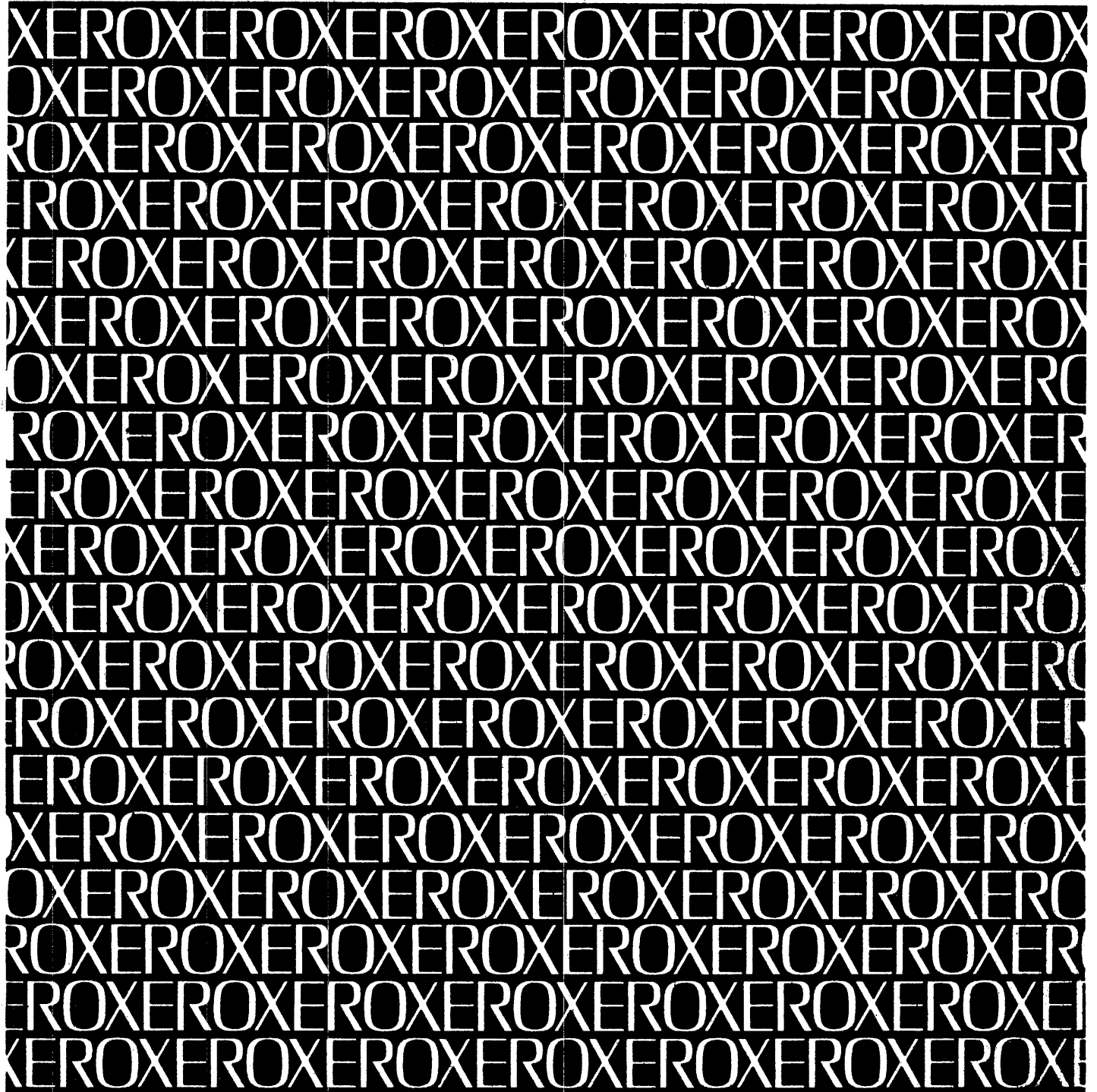

XEROX

Xerox Control Program-Five (CP-V)

Xerox 560 and Sigma 6/7/9 Computers

Remote Processing Reference Manual

90 30 26C

December 1975

NOTICE

This publication documents the D00 version of Control Program-Five (CP-V). The publication is a revision to the B edition of this manual (90 30 26A, dated February 1974) and the revision packages 90 30 26B-1(9/74) and 90 30 26B-2(4/75). Vertical lines in the outer margin of pages indicated changes that reflect the D00 version of CP-V.

RELATED PUBLICATIONS

<u>Title</u>	<u>Publication No.</u>
Xerox Sigma 6 Computer/Reference Manual	90 17 13
Xerox Sigma 7 Computer/Reference Manual	90 09 50
Xerox Sigma 9 Computer/Reference Manual	90 17 33
Xerox 560 Computer/Reference Manual	90 30 76
Xerox Control Program-Five (CP-V)/OPS Reference Manual	90 16 75
Xerox Control Program-Five (CP-V)/SM Reference Manual	90 16 74
Xerox Control Program-Five (CP-V)/SP Reference Manual	90 31 13
Xerox Control Program-Five (CP-V)/BP Reference Manual	90 17 64
Xerox Control Program-Five (CP-V)/TS Reference Manual	90 09 07
Xerox Control Program-Five (CP-V)/TS User's Guide	90 16 92
Xerox Control Program-Five (CP-V)/TP Reference Manual	90 31 12
Xerox Control Program-Five (CP-V)/Common Index	90 30 80
Xerox EASY/LN, OPS Reference Manual	90 18 73
Xerox BASIC/LN, OPS Reference Manual	90 15 46
Xerox FLAG/Reference Manual	90 16 54
Xerox Meta-Symbol/LN, OPS Reference Manual	90 09 52
CP-V Assembly Program/Reference Manual	90 30 00
Xerox Extended FORTRAN IV/LN Reference Manual	90 09 56
Xerox Extended FORTRAN IV/OPS Reference Manual	90 11 43
Xerox FORTRAN Debug Package (FDP)/Reference Manual	90 16 77
Xerox ANS COBOL/LN Reference Manual	90 15 00
Xerox ANS COBOL/OPS Reference Manual	90 15 01
Xerox APL/LN, OPS Reference Manual	90 19 31
Xerox Manage/Reference Manual	90 16 10
Xerox Sort-Merge/Reference Manual	90 11 99
Xerox Functional Mathematical Programming System (FMPS)/Reference Manual	90 16 09
Xerox SL-1/Reference Manual	90 16 76
CIRC-AC/Reference Manual and User's Guide	90 16 98
CIRC-DC/Reference Manual and User's Guide	90 16 97
CIRC-TR/Reference Manual and User's Guide	90 17 86
Xerox 1400 Series Simulator/Reference Manual	90 15 02

Manual Content Codes: BP - batch processing, LN - language, OPS - operations, RP - remote processing, RT - real time, SM - system management, SP - system programming, TP - transaction processing, TS - time-sharing, UT - utilities.

The specifications of the software system described in this publication are subject to change without notice. The availability or performance of some features may depend on a specific configuration of equipment such as additional tape units or larger memory. Customers should consult their Xerox sales representative for details.

CONTENTS

PREFACE	v	Device Commands _____	19
COMMAND SYNTAX NOTATION	vi	Suspend Command _____	19
GLOSSARY	vii	RBSUSPEND _____	19
1. INTRODUCTION	1	Restart Commands _____	19
Definition of CP-V _____	1	RBCONTINUE _____	19
Remote Processing _____	1	RBREPRINT _____	19
Remote Terminals _____	1	RBABORT _____	20
Hardware Connection of Remote Terminals _____	2	RBSAVE _____	20
Workstation _____	3	RBALIGN _____	20
Scope of the Manual _____	4	Other Device Commands _____	20
2. LOCAL AND REMOTE USERS	5	RBLOCK _____	20
LDEV Command _____	5	RBUNLOCK _____	20
Using LDEV to Receive Input _____	8	RBFORM _____	20
Using LDEV to Send Output _____	9	RBSIZE _____	20
Examples of LDEV Usage _____	9	RBCTL _____	20
LDEV Processor _____	10	Changing Forms _____	21
JOB Command _____	11	Entering a Noncontrol Input File _____	21
The ISCL Processor _____	12	2780 RBT Error Recovery _____	21
The ISCL Commands _____	12	Remote Processing Messages _____	21
Copy a File from a Remote CP-V System _____	13	4. CENTRAL SITE OPERATOR	25
SEND _____	13	5. SYSTEM MANAGER	27
Send a File to a Remote CP-V System _____	13	Establishing Remote Processing at SYSGEN _____	27
SEND _____	13	:DEVICE Command _____	27
Delete a File at a Remote CP-V System _____	13	:SDEVICE Command _____	27
DELETE _____	13	:MON Command _____	27
List a File at a Remote CP-V System _____	13	:FECP Command _____	28
LIST _____	13	Defining Workstations _____	28
Record Size Restrictions _____	14	WORKSTATION Command _____	29
Vertical Format Control at Remote Printers _____	15	Device Selection _____	33
7670 RBT Printers _____	15	General Examples _____	34
IRBT Printers _____	15	Defining a Master Computer System as a	
2780 RBT Printers _____	16	Workstation in a Slave CP-V _____	35
3. REMOTE OPERATOR	17	Defining Workstations for CP-V to	
Remote Processing Control Commands _____	17	CP-V Communication _____	35
General Commands _____	17	X Command _____	40
RBID _____	17	ISCL/RATLER Management _____	40
RBDISC _____	17	ISCL Standing Orders _____	40
RBXXX _____	17	INDEX	59
RBMSG _____	17	APPENDICES	
RBDEV _____	17	A. CONNECTING REMOTE SITE AND CENTRAL	
RBINFO _____	18	SITE TELEPHONE LINES	41
File Handling Commands _____	18	Full-Duplex Configuration _____	41
RBPRIO _____	18	Half-Duplex Configuration _____	42
RBHOLD _____	18	B. OPERATION OF IRBTS AND 2780S	43
RBRETRIEVE _____	18	Preparing for Connection to CP-V _____	43
RBDELETE _____	18	Logging onto CP-V _____	43
RBSTATUS _____	19	FIN Command _____	44
RBSWITCH _____	19	Interruptions in Phone Connection _____	44
		Device Control Commands _____	44

C. OPERATION OF THE XEROX 7670 REMOTE BATCH TERMINAL	45
Preparing an RBT for Connection to the System	45
Logging On	45
Entering Job Streams	45
Receiving Punched Output	47
Suspending an Output Symbiont	47
Logging Off	47
Disconnecting an RBT from the System	47
Handling Errors	47

D. MULTILEAVING	49
String Control Byte (SCB)	49
Record Control Byte (RCB)	51
Subrecord Control Byte (SRCB)	51
Block Control Byte (BCB)	51
Function Control Sequence (FCS)	52

E. OPERATING CP-V AS SLAVE IRBT TO IBM HASP SYSTEM	53
SYSGEN Considerations	53
SYSGEN Options	53
Defining the Workstation	53
Operating Considerations	53
Logging On	53
System or Line Failures	54

F. ERROR LOG RECORD	55
---------------------	----

FIGURES

1. CP-V Remote Processing Complex	2
2. CP-V Remote Processing Hardware	3
3. WORKSTATION Command Options	33
4. Sample Definition of a Master System as a Workstation in CP-V	36
5. Definition of Workstation CPVA in Computer A	37
6. Definition of Workstation CPVA in Computer B	38
7. Communication Paths between CPVA and CPVB	39

8. Definition of an ISCL/RATLER Workstation	40
A-1. Connecting a Remote Site to the System	41
C-1. Xerox 7670 Remote Batch Terminal	46
C-2. Xerox 7670 RBT Control Panel	46
C-3. Xerox 7670 RBT Maintenance Panel	47
D-1. Typical Multileaving Data Transmission Block	50

TABLES

1. LDEV Command Options	5
2. ISCL Error Messages	14
3. MAILBOX Messages	15
4. Remote Processing Messages	22
5. ISCL/RATLER Messages to the Remote Operator	24
6. Central Site Operator Key-Ins	25
7. Central Site Messages	26
8. General Options of the WORKSTATION Command	29
9. Device Options of the WORKSTATION Command	31
10. Standard IRBT Device Option Values	33
D-1. Text Control Characters Used In Multileaving	49
F-1. Xerox 7670 RBT - RP1, RP3, RP4	55
F-2. Xerox 7670 RBT - RP2	56
F-3. IBM 2780 RBT - RP1 and RP4	56
F-4. IBM 2780 RBT - RP2 and RP3	57
F-5. IRBT - RP1 and RP4	57
F-6. IRBT - RP2 and RP3	58

PREFACE

This manual is the principal source of information about the remote processing features of CP-V. All information about remote processing for all computer personnel (remote and local users, system managers, remote site operators, and central site operators) is included in the manual.

Manuals describing other features of CP-V are outlined below.

- The CP-V Time-Sharing Reference Manual, 90 09 07, is the principal source of information for the time-sharing features of CP-V. The purpose of the manual is to define the rules for using the Terminal Executive Language and other on-line processors.
- The CP-V Time-Sharing User's Guide, 90 16 92, describes how to use the various time-sharing features. It presents an introductory subset of the features in a format that allows the user to learn the material by using the features at a terminal as he reads through the document.
- The CP-V Batch Processing Reference Manual, 90 17 64, is the principal source of reference information for the batch processing features of CP-V (i.e., job control commands, system procedures, I/O procedures, program loading and execution, debugging aids, and service processors).
- The CP-V System Programming Reference Manual, 90 31 13, describes the CP-V features that are designed to aid the system programmer in the development, maintenance, and modification of the CP-V system.
- The CP-V System Management Reference Manual, 90 16 74, is the principal source of reference information for the system management features of CP-V. It defines the rules for generating a CP-V system (SYSGEN), authorizing users, maintaining user accounting records, maintaining the file system, monitoring system performance, and other related functions.
- The CP-V Operations Reference Manual, 90 16 75, is the principal source of reference information for CP-V computer operators. It defines the rules for operator communication (i.e., key-ins and messages), system start-up and initialization, job and system control, peripheral device handling, recovery and file preservation.
- The CP-V Transaction Processing Reference Manual, 90 31 12, provides information about dynamically modifying and querying a central database in a transaction processing environment. The manual is addressed to system managers, database administrators, applications programmers, and computer operators.
- The CP-V Common Index, 90 30 80, is an index to all of the above CP-V manuals.

Information for the language and application processors that operate under CP-V is also described in separate manuals. These manuals are listed on the Related Publications page of this manual.

COMMAND SYNTAX NOTATION

Notation conventions used in command specifications and examples throughout this manual are listed below.

Notation	Description
lowercase letters	<p>Lowercase letters identify an element that must be replaced with a user-selected value.</p> <p style="padding-left: 40px;">CRn_{dd} could be entered as CRA03.</p>
CAPITAL LETTERS	<p>Capital letters must be entered as shown for input, and will be printed as shown in output.</p> <p style="padding-left: 40px;">DPn_{dd} means "enter DP followed by the values for n_{dd}".</p>
[]	<p>An element inside brackets is optional. Several elements placed one under the other inside a pair of brackets means that the user may select any one or none of those elements.</p> <p style="padding-left: 40px;">[KEYM] means the term "KEYM" may be entered.</p>
{ }	<p>Elements placed one under the other inside a pair of braces identify a required choice.</p> <p style="padding-left: 40px;">{ A id } means that either the letter A or the value of id must be entered.</p>
...	<p>The horizontal ellipsis indicates that a previous bracketed element may be repeated, or that elements have been omitted.</p> <p style="padding-left: 40px;">name [,name]... means that one or more name values may be entered, with a comma inserted between each name value.</p>
:	<p>The vertical ellipsis indicates that commands or instructions have been omitted.</p> <p style="padding-left: 40px;">MASK2 DATA,2 X'IEF' : BYTE DATA,3 BA(L(59))</p> <p style="padding-left: 80px;">means that there are one or more statements omitted between the two DATA directives.</p>
Numbers and special characters	<p>Numbers that appear on the line (i.e., not subscripts), special symbols, and punctuation marks other than dotted lines, brackets, braces, and underlines appear as shown in output messages and must be entered as shown when input.</p> <p style="padding-left: 40px;">(value) means that the proper value must be entered enclosed in parentheses; e.g., (234).</p>
Subscripts	<p>Subscripts indicate a first, second, etc., representation of a parameter that has a different value for each occurrence.</p> <p style="padding-left: 40px;">sysid₁,sysid₂,sysid₃ means that three successive values for sysid should be entered, separated by commas.</p>
Superscripts	<p>Superscripts indicate shift keys to be used in combination with terminal keys. c is control shift, and s is case shift.</p> <p style="padding-left: 40px;">L^{CS} means press the control and case shift (CONTROL and SHIFT) and the L key.</p>
Underscore	<p>All terminal output is underscored; terminal input is not.</p> <p style="padding-left: 40px;"><u>IRUN</u> means that the exclamation point was sent to the terminal, but RUN was typed by the terminal user.</p>
Ⓞ Ⓡ Ⓛ	<p>These symbols indicate that an ESC (Ⓞ), carriage return (Ⓡ), or line feed (Ⓛ) character has been sent.</p> <p style="padding-left: 40px;"><u>IEDIT</u> Ⓡ means that, after typing EDIT, a carriage return character has been sent.</p>

GLOSSARY

- batch job** a job that is submitted to the batch job stream through the central site card reader, through an on-line terminal (using the Batch processor), or through a remote terminal.
- ghost job** a job that is neither a batch nor an on-line program. It is initiated and logged on by the monitor, the operator, or another job and consists of a single job step. When the ghost program exits, the ghost is logged off.
- held file** an output file ready for transmission to a remote site but not being transmitted because either the destination remote site is not logged on or the remote site operator has specifically requested "held" status. Files that are to be output on local devices cannot be held. Message files (see below) are never held.
- job stream** a set of input records consisting of one or more jobs and/or remote control commands and ending with a FIN control command. A FIN command by itself is not a job stream and is ignored. The FIN command is not used if the stream is input from an IRBT; instead, its equivalent is entered automatically by the IRBT.
- logical device stream** an information stream that may be used when performing input from or output to a symbiont device. At SYSGEN, up to 15 logical device streams are defined. Each logical device stream is given a name (e.g., L1, P1, C1), each is assigned to a default physical device, and each is given default attributes. The user may perform I/O through a logical device stream with the default physical device and attributes or he may change the physical device and/or attributes to satisfy the requirements of his job.
- message file** a symbiont print file containing information for a remote site identified by a given workstation name. It includes all remote control commands transmitted by the remote operator, error messages, operator messages, etc. A message file is transmitted to the remote site at log-on, upon receipt of a job stream, in reply to operator commands, and when the central site operator directs a message to the workstation.
- on-line job** a session at an on-line terminal that begins with the log-on and ends with the log-off.
- protocol** a set of control codes, data formats, and standardized response procedures that regulate the transmission of data between two communicating systems in a predetermined manner.
- remote control command (RBCC)** a system control command that is unique to the remote processing system.
- remote site** the location of a remote terminal.
- remote user** any user utilizing CP-V via the remote processing system.
- short block control character (EM)** a special character for cards that allows shorter images to be punched and read by a Xerox 7670 Remote Batch Terminal, thus increasing throughput. The EM character appears as an 11-9-8-1 punch in the first column after the last non-blank column of a card. All columns after an EM character are ignored by the remote batch terminal. The user may supply EM characters on input decks. The remote processing system automatically supplies EM characters for 7670 output decks unless the user specifies that EM characters are not to be punched. Cards with EM characters cannot be used as input at the central site.
- suspended file** a remote site symbiont output file for which output in progress was interrupted (but not aborted) by manual intervention by the remote site operator to allow the input of a job stream or by the RBSUSPEND command.
- symbiont** a monitor routine that transfers information between disk storage and a peripheral device independent of and concurrent with job processing.
- symbiont retry point** a point within an output symbiont file that is currently being output. The point dynamically changes and is always several pages behind that which is currently being output. If the current output point is within three pages of the beginning of the output file, the symbiont retry point is the beginning of the file.
- sysid** a unique number used to identify a job submitted to the CP-V system. It is assigned sequentially at job input time.

1. INTRODUCTION

DEFINITION OF CP-V

Control Program-Five (CP-V) is a comprehensive operating system designed for use with Xerox 560 and Sigma 6/7/9 computers together with a wide variety of peripheral devices. The CP-V system provides for five concurrent modes of operation.

- Time-sharing
- Batch processing
- Real-time processing
- Remote processing
- Transaction processing

The time-sharing and batch modes are complementary, yet compatible, modes of operation that provide the user with file management and program compilation, execution, and debugging services. CP-V time-sharing allows up to 128 terminal lines to be connected to the central computer at one time. The CP-V multibatch system is designed to maximize utilization of the system's resources while preventing conflicts in resource use. Batch jobs may be submitted to the batch job stream through the central site card reader, from an on-line terminal, or from a remote site via the remote processing system.

Real-time processing involves reacting to external events (including clock pulses) within microseconds. Selected external events are allowed to interrupt the real-time user's program so that they can be processed at the time they occur. After an interrupt has been processed, control may then return to the interrupted program or may be directed elsewhere. Real-time facilities are available to both the on-line and batch user (and also to a ghost user), provided the user has a sufficient privilege level.

The transaction processing feature of CP-V is an efficient and economical approach to centralized information processing and is a generalized package that is designed to meet the requirements of a variety of business applications. Transaction processing facilities provide an environment in which several users at remote terminals may enter business transactions, simultaneously utilizing a common database. The transactions are processed immediately, as they are received, by application programs written especially for the particular installation.

REMOTE PROCESSING

The purpose of the remote processing system is to provide for flexible communication between CP-V and a variety of remote terminals. Remote terminals can range from a simple card reader and line printer combination to another large-scale computer system with an assortment of peripheral

devices. Important features of the remote processing system include

- Support of a wide variety of peripherals at the remote site. Through monitor and user interfaces, virtually any type of device (e.g., tape, disk, plotter) may be accessed with remote processing.
- Computer-to-computer communication. A remote site may be another large-scale computer, and files of data may be transferred between user programs at the central and remote computers.
- Slave/master status. A CP-V system may act as the central site to some remote terminals and as a remote terminal to other computers, simultaneously. This feature encourages the construction of communications networks.
- Complete user interface. Any user (batch, on-line, ghost) of a CP-V system can communicate with any number of devices at one or several remote sites. When data is being sent by a user program to a remote site, the remote site need not be connected since CP-V automatically buffers on RAD or disk for deferred transmission.
- Processing of jobs from remote sites at the central site. Jobs are sent from the remote site to the central site, are processed there, and may direct output to the originating remote site, a central site device, or another remote site as specified by the remote site user.
- Dynamic definition of remote stations. Remote stations can be added, deleted, or modified during system operation. The definition of remote stations is not SYSGEN-dependent.

Basically, CP-V remote processing is a machine-to-machine communication mechanism that allows output files for pseudo devices called streams to be combined into transmission blocks and transmitted over communications lines. Blocks received over these lines are deblocked into symbiont input files for logical device streams (or real devices) at the central or remote site.

REMOTE TERMINALS

Two basic types of remote terminals are supported by CP-V: Remote Batch Terminals (RBTs) and Intelligent Remote Terminals (IRBTs).

An RBT is a card reader, card punch, and line printer combination which is used primarily to allow batch processing I/O functions to be performed at remote sites. That is, a job is input to the system from the remote site card reader, the job is processed at the central site, and the output is sent to the remote site line printer or card punch. The output may optionally be directed to the central site or to another remote site. The Xerox 7670 RBT or any computer that exactly emulates it (Univac DCT 2000 compatible) is supported by CP-V. Operation of the 7670 is described in Appendix C.

The IBM 2780 RBT or 3780 RBT, or any computer that exactly emulates them, is supported by CP-V given the following factors:

- EBCDIC transmission code.
- Nontransparent line protocol.
- Single record blocks or multirecord blocks of 400 bytes for 2780 RBTs and 512 bytes for 3780 RBTs.
- Support for multidrop lines is not provided.

An IRBT can be either a mini-computer system for which the primary function is to control the operation of peripheral equipment (e.g., COPE 1200) or another large-scale computer system (e.g., another CP-V system). Any computer system that supports the IBM HASP Multileaving protocol[†] may act as an IRBT to CP-V.

The remote processing system is designed so that the CP-V system may act as the central site to a set of remote terminal while simultaneously acting as a remote terminal to one or more other systems. A system that is acting as the central site is referred to as the "master" system and a system that is acting as a remote terminal is referred to as a "slave" system.

To the CP-V system, the role of master and slave manifests itself only at log-on time. After the data-set to data-set communication path is established, the slave logs onto the master. (The master cannot log onto the slave.) Once the log-on is complete, the communication path between the

[†]This and all other reference to "HASP" and "Multileaving" in this document refer to the HASP Multileaving protocol as described in HASP Version 2.3 program documentation and not to the IBM HASP operating system, except where IBM HASP is specifically noted.

master and slave is symmetrical — simply streams of data flowing in both directions over the communication path.

When it is intended that the CP-V system act as a slave terminal on a particular line, the operator must use the RBLOG key-in (described in Chapter 4) to establish the workstation name of the master on that line since the master does not identify itself to the slave.

Four fundamental modes of remote processing are

1. A CP-V master system connected to one or more slave Xerox 7670 and/or IBM 2780 RBTs.
2. A CP-V master system connected to one or more slave mini-computer IRBTs.
3. A CP-V system communicating with another CP-V system.
4. A CP-V system acting as a slave IRBT connected to another computer system acting as the master computer.

These four modes may be combined to provide a large variety of communications networks. An example of such a network is given in Figure 1. (The arrows point to the RBTs and slave IRBTs.)

HARDWARE CONNECTION OF REMOTE TERMINALS

A remote terminal is connected to the central site over a communication line that is either a hardwired line or a switched line.

If the connection is over a hardwired line, the remote site must be physically near the central site.

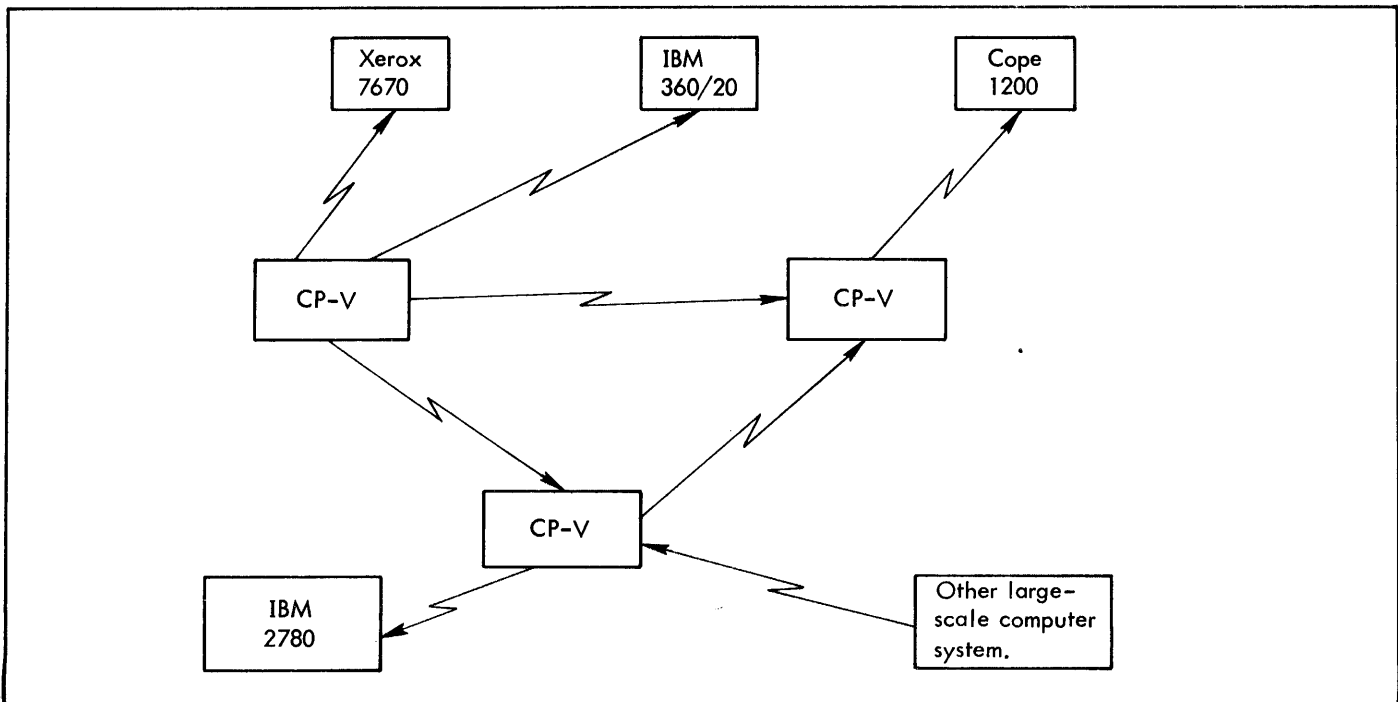

Figure 1. CP-V Remote Processing Complex

If the connection is by switched line, two data sets (modems) are required. The data sets provide interfaces between the line and the remote terminal and between the line and a data set controller (described below) at the central site. The data sets convert device signals to telephone tones and telephone tones to device signals. Connecting the remote site to the central site with a telephone line and data sets is described in Appendix A.

All remote terminals require a data set controller (DSC) for interface with the central site. A virtually unlimited number of RBTs and IRBTs may be connected to the computer via a particular DSC, but only one may be connected at a time. Therefore the maximum number of remote sites that may be connected concurrently is determined, not by the number of remote terminals, but by the number of DSCs at the central site. CP-V supports up to 30 DSCs of the following types:

- Xerox 7601, which may be used only with a Xerox 7670 RBT.
- Xerox 7605, which may be used with any RBT or IRBT.

- Options that may be added to either of the above DSCs are
 - Xerox 7602, which provides full-duplex operations.
 - Xerox 7604, which provides for local connection.

Figure 2 depicts the relationship between the central site, remote sites, data sets, and data set controllers.

WORKSTATION

A workstation (WS) is a collection of information that defines both the identity and hardware characteristics of a remote site at a particular time. A workstation may represent a particular remote site, a particular group of users at one remote site, or a group of users utilizing several different remote sites. The definition of a workstation specifies items such as

- Name of the workstation.
- Type of terminal to be used (RBT or IRBT).

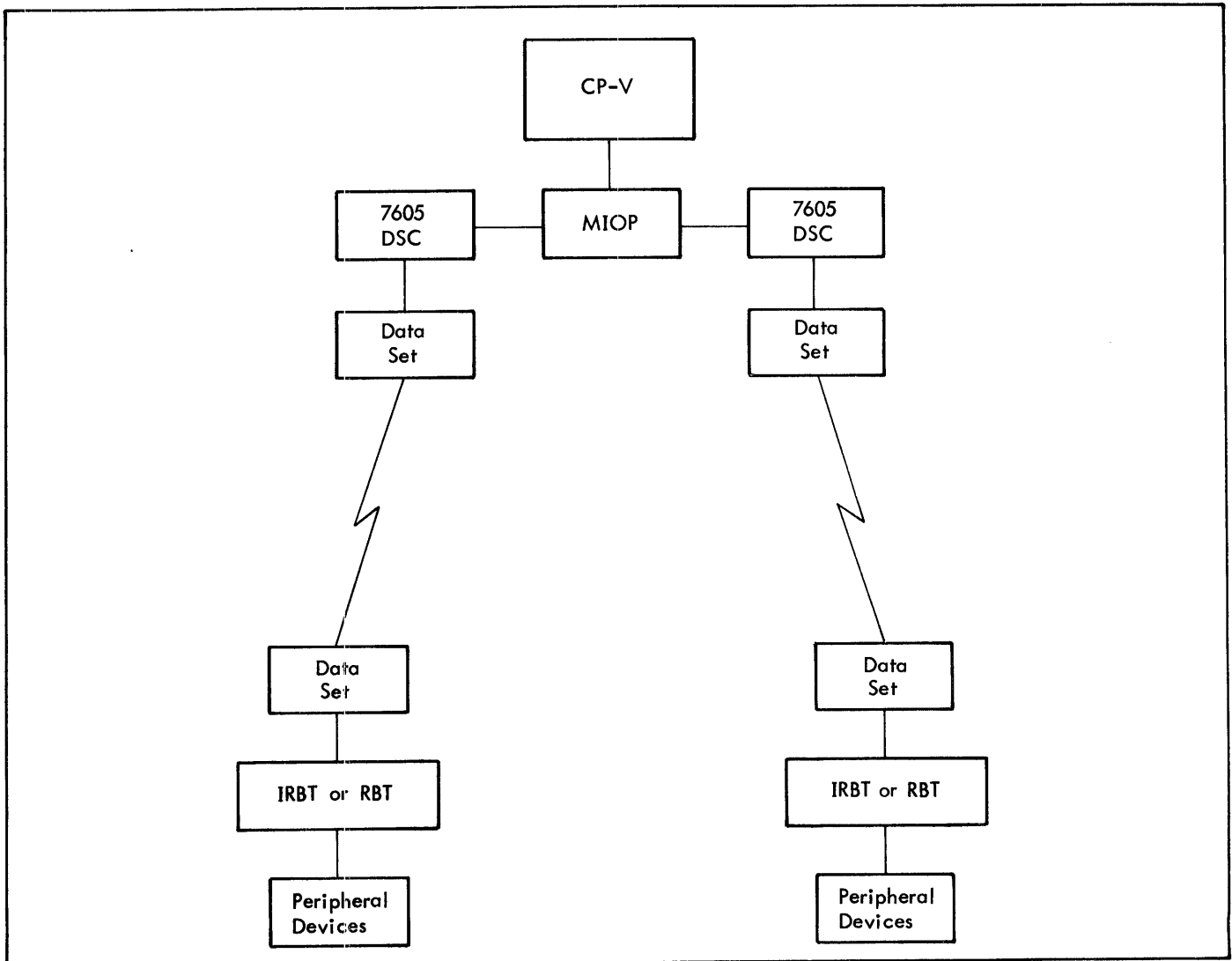

Figure 2. CP-V Remote Processing Hardware

SCOPE OF THE MANUAL

- Whether or not jobs to be run in the :SYS account may be submitted from the workstation.
- Maximum priority for jobs submitted from the workstation.
- Whether the workstation will be a slave computer or the master computer (if the type is IRBT).
- Remote peripheral devices to be associated as part of the workstation (if it is an IRBT).
- Attributes of devices defined for the workstation.

Each workstation is given a one- to eight-alphanumeric character workstation name (WSN). Local devices at a CP-V system have the workstation name LOCAL.

A workstation is not, as the name might imply, limited to one physical location. A user may log on as a given workstation at any remote site that has the appropriate hardware characteristics. Each remote site may have several workstations defined for it, but only one workstation may be active on a given line at a given time. If the remote site has more than one line (which could only be true if it were a large-scale computer), then more than one workstation may be logged on currently from that site.

Workstations may be defined dynamically any time during system operation using the system management processor Super. The attributes of workstations may also be changed and workstations may be deleted using Super during system operation.

This manual is the central source of information about the remote processing system. It describes all external aspects of remote processing and contains sections for system users, system operators, and system managers. The remaining chapters in the manual are

Chapter 2 – Remote and Local Users

Chapter 3 – Remote Operator

Chapter 4 – Central Site Operator

Chapter 5 – System Manager

In each chapter, the information required by the personnel type indicated by the chapter title is documented. However, there is some overlap. Specifically,

- Many remote users will find Chapter 3 helpful.
- CP-V operators at CP-V systems that are acting as slave remote terminals should read both Chapters 3 and 4.
- The system manager will find useful information in all of the chapters.

Much of the material in this manual is repeated in other CP-V manuals. Of particular importance, all of the information for the central site operator is repeated in the CP-V/OPS Reference Manual, 90 16 75.

2. LOCAL AND REMOTE USERS

This chapter discusses remote processing from the point of view of both central site and remote site users. When the remote site is another CP-V system, the ISCL processor facilitates manipulation of CP-V managed files for both local and remote users. The ISCL processor is described later in this chapter.

Two commands, LDEV and JOB, are the other primary methods that local and remote users can use to take advantage of remote processing capabilities.

These are the two CP-V commands that have options that allow a user at one site to direct a file to another site. The LDEV command allows users to direct any file of information almost anywhere within the reaches of remote processing — to a symbiont device at the central site or to any device at a specific remote workstation. The JOB command, with a more limited application to remote processing, provides a means of directing the print and punch output of the job to a specified workstation or to the central site.

Before discussing these commands, it is important to note that the remote user may submit jobs to the central site that make full use of the LDEV and JOB command remote processing features provided that the central site is a CP-V system. Because of the on-line/batch compatibility of CP-V, the operations described in this chapter may be used by both on-line and batch users. In cases where the master computer is a system other than CP-V, the remote user must be familiar with the remote processing commands and capabilities of the particular master system.

At the conclusion of this chapter, two other topics of interest to local and remote users are discussed.

1. Record size restrictions.
2. Vertical format control for remote devices.

LDEV COMMAND

A logical device stream is an information stream which may be attached to any symbiont device that the user specifies. (Symbiont devices include devices such as the line printer, card reader, card punch, and plotter at the central site and all devices at remote workstations.) At SYSGEN, up to 15 logical device streams may be defined. Each is given a name (e.g., C1, L1, P1), each is assigned to a default physical device, and attributes are defined for the physical device. Three logical device streams — C1, L1, and P1 — are always defined and are given default attributes at SYSGEN. The user may perform I/O through a logical device stream with the default physical device and attributes or he may change the physical device assignment and/or attributes to satisfy the requirements of his job. He makes any necessary changes through use of the LDEV command. The information about the logical device stream is stored in a cooperative context block, providing for centralized information about the physical device even though I/O to that device may arise through more than one DCB within a job.

The LDEV command is available in both the on-line and batch modes. The format of the command is

```
LDEV stream-id[, (option)]...
```

where

stream-id specifies the two-character name of the stream to be referenced. This must be the name of one of the logical device streams defined during SYSGEN (e.g., C1, L1, P1).

options are as defined in Table 1. The options may appear in any order.

Table 1. LDEV Command Options

Option	Description
AINIT	Specifies that the attributes for the stream are to be initialized with the attributes specified on this LDEV command and that system defaults are to be supplied wherever an attribute is not specified. Any attributes specified for the stream on a previous LDEV command are to be ignored. AINIT is the default for the AINIT, ASAVE, and AREL options.
AREL	Specifies that the system table containing the attributes of this stream (which may have been set as the result of previous LDEV commands) is to be released and that the attributes are not to be reinitialized. Any other options specified (except DELETE) in this command will be ignored.

Table 1. LDEV Command Options (cont.)

Option	Description
ASAVE	Specifies that the current attributes for the stream are to be changed only by options explicitly specified on this LDEV command. Other LDEV-specifiable attributes (which may have been set as the result of previous LDEV commands) are not to be changed.
CONCURR	Places the symbiont output stream in concurrent output mode, a mode in which output is broken into groups ("chunks") and released to the symbiont stream for output. Once this stream has been selected by the symbiont for printing or punching, then the particular device is held until all output produced by the job has been processed, except as otherwise directed by an operator key-in. If CONCURR is not the only option specified, then already prepared output will be packaged for printing in its entirety and a newly bannered stream will be created for subsequent output. The COPIES option may not be specified when CONCURR is specified.
COPIES,value	Specifies the number of times the file is to be processed to produce multiple copies. The range of values that may be specified is 1-255. The default value is 1.
COUNT,tab	Specifies that page counting is to be done and specifies the column in which the most significant digit of the page count is to be listed. The value of "tab" must be appropriate for the particular physical device. (Note that if COUNT is specified for the LO device and a TITLE control command is also specified, the page count will be superimposed on the title line.) The default is no page counting.
DELETE	Specifies that if output currently exists for this stream but has not yet been dispatched for processing, it is to be deleted. (If such a stream exists and DELETE is not specified, the output for the stream is dispatched for processing.) If input is currently being accessed through this stream, any part of the stream that has not been read will automatically be deleted whether or not DELETE is specified.
DEV,type	Specifies the device type, where type is the two-character mnemonic of the device to be associated with the stream. Valid mnemonics are resource mnemonics either of the central site or of a remote workstation. Central site mnemonics are those defined for symbiont devices during SYSGEN (e.g., CR, LP). Remote mnemonics are those specified when defining a workstation with Super (e.g., OC, CR).
DRC	Requests that monitor logical record formatting implied by the DEV option not be performed. Any record formatting necessary will be supplied by the user. If DRC is not specified, the monitor will perform logical record formatting.
FFORM,name	Specifies the future form name (as below, with FORM) of the form to be used when the form change procedure (M:DEVICE(FORM/FNAME)) is specified in the program for the stream. When M:DEVICE(FORM/FNAME) is encountered, the stream will be dispatched for processing and restarted with 'name' as the stream form. The default is none.
FORM,name	Specifies the one- to four-character name of an installation-determined paper form or card stock and is used in output scheduling for the device. The default is to have no special scheduling (i.e., the operator will determine which form to use). If used on input, name specifies the one- to four-character name of a noncontrol input file. (FORM and NAME may be used interchangeably.)
FPC, name	Specifies the one- to four-character name of an installation-determined form overlay and is used in output scheduling for the Xerox 1200 or a similar device. The default is to have no special scheduling (i.e., the operator will determine which overlay to use if any).
{ IN } { OUT }	Specifies the direction of the stream. The default is OUT.
JDE, value	Specifies the job descriptor entry to be used in output scheduling for the device. The value must be in the range 0-89 and specifies an <u>installation defined</u> procedure describing printer setup attributes (e.g., VFC tape).

Table 1. LDEV Command Options (cont.)

Option	Description
LINES,value	Specifies the number of printable lines per logical page. A maximum of 32,767 lines per page may be specified. The default is determined at SYSGEN.
NAME,name	Specifies the one- to four-character name of a noncontrol input file (see below, "Noncontrol Input Files"). If used on output, name specifies the one- to four-character name of an installation-determined paper form or card stock and is used in output scheduling for the device. (NAME and FORM may be used interchangeably.)
NOVFC	See VFC below.
OUT	See IN above.
SEQ[, id]	Specifies that punched output is to have decimal sequencing in columns 72-80. If a user-defined id is specified, it will be punched in columns 73-76 of each card. Sequencing begins with 0000.
SPACE,value[, top]	Specifies the spacing between lines (value) and between the top of each page and the first line printed (top). A value of 1 indicates that lines are to be single spaced. The greatest value that may be specified for value and top is 15.
SRCB	<p>Applies to remote processing and is only valid when the WSN option is specified. It specifies that the user will supply a device-dependent control byte as the first byte of each record if this is an output stream, or that he wishes to receive it as the first byte of records if the stream is input. The following conditions apply:</p> <ol style="list-style-type: none"> 1. For remote devices for which the SRCB option of the WORKSTATION command was set to U, the SRCB option of the LDEV command must be specified. 2. The LDEV SRCB option may not be specified for remote input devices unless the SRCB option of the WORKSTATION command was set to U. 3. The LDEV SRCB option is legal for any output device.
{ VFC NOVFC }	Specifies whether or not vertical format control characters are to be used. (These two options are only legal for line printers.) VFC requests that a default vertical format control character be added to all records. NOVFC requests that the format character be stripped from the record if present. The default is VFC.
WSN, { name \$ }	Specifies the workstation name of the remote device that is to receive the stream, where name can be from one to eight alphanumeric characters. The default is local output. If a dollar sign (\$) is specified, the name of the workstation on the JOB command (if one is specified) effectively replaces the dollar sign. If no workstation name was specified on the JOB command or if no JOB command was used, the name of the workstation from which the job was submitted effectively replaces the dollar sign. (The dollar sign option allows a job to be run from more than one workstation without necessitating respecification of the workstation name on the LDEV command.)

Examples:

1. The following command requests association of stream L1 with the local line printer named LP and specifies that lines per page is to be 60. All other attributes are to be supplied by default.

```
!LDEV L1,(DEV,LP),(LINES,60)
```

2. The following command requests association of stream L5 with the line printer named LL at remote workstation LAX. All other attributes are to be supplied by default.

```
!LDEV L5,(DEV,LL),(WSN,LAX)
```

If an LDEV command specifies DEV=LP or CP and no WSN, the stream is LDEVed to the system listing or system punch device respectively (if it exists) at the workstation of origin. The workstation of origin is the one from which the job was submitted or one on the JOB command which overrides it. If the appropriate device is not present, the output is sent to the LOCAL device.

For example:

```
!JOB X, Y, 7, WSN1
.
.
.
!LDEV L2, (DEV, LP)
```

is identical to:

```
!JOB X, Y, 7
.
.
.
!LDEV L2, (DEV, LP), (WSN, WSN1)
```

USING LDEV TO RECEIVE INPUT

The LDEV command can be used to receive input transmitted via remote processing only if the receiving site is a CP-V system (either master or slave).

Two types of input devices may be defined for IRBTs and the central site:

1. CTL devices – control devices from which system control commands such as the JOB command or remote control commands may be transmitted. (The card reader at an IRBT is usually a CTL device.)
2. NCTL devices – noncontrol devices from which files of data may be transmitted; i.e., files from NCTL devices are not scanned for system control commands (except EOD and FIN).

Input from CTL devices is always scanned (unless otherwise requested) by the receiving operating system for system control commands which tell the system what is to be done with the input (e.g., run it as a job).

When input is from an NCTL device, a user job at the receiving site may access the input via the LDEV command. Jobs are not allowed to access input that was sent from a CTL device unless that input was preceded by the command

```
!!NCTL [name]
```

where name specifies the one- to four-character name of the noncontrol input stream.

The !!NCTL command specifies that the input that immediately follows is to be treated as though it had arrived from an NCTL device – it is not to be scanned for system control commands. This feature provides, among other things, a means of transmitting jobs that are to be run at a later time.

It is important to note that jobs at the receiving site can never access the actual physical input device at the sending site. They can only access the input from the device once it has arrived. The input is not restricted to being received by a job submitted by a user at the receiving site. For example, a user at a remote site may submit a job to the central site for the specific purpose of reading a noncontrol file from a device at the same remote site.

To read a file that has been input via remote processing, the user assigns one of the logical device streams to the device and the WSN of the file and then reads that stream. For example, the command

```
!LDEV C2,(WSN,STA6),(DEV,CR)
```

assigns logical device stream C2 to the first available cooperative input file from device CR at workstation STA6. The file may then be read by a series of commands such as

```
!PCLt
COPY C2 TO FILE
END
```

provided that either CR is a noncontrol device or that the file was preceded by a !!NCTL command.

^tThe Peripheral Conversion Language (PCL) is described in the CP-V/BP Reference Manual, 90 17 64, and in the CP-V/TS Reference Manual, 90 09 07.

In this example, the input will be copied to a standard CP-V consecutive file called FILE. Cooperative input files are deleted as they are read, so it is good practice to copy them to standard files before accessing the data.

The above example obtains the first available (first to enter the system) cooperative file that has no name from the device to which C2 is assigned. To access a particular named cooperative input file, the LDEV command could be modified as follows:

```
!LDEV C2,(WSN,STA6),(DEV,CR),(IN),(NAME,ABCD)
```

This command connects cooperative stream C2 to the input cooperative file from workstation STA6 and device CR with the name ABCD.

The LDEV command can be used to receive input sent by a central site to a slave CP-V IRBT because the central site always has a workstation name defined for it for use by jobs at the slave CP-V. (Actually, the central site is defined as a workstation by the slave CP-V through use of the Super processor.)

The SRCB option of the LDEV command is useful for devices with nonstandard record control properties. SRCB may be specified if, and only if, it was specified at the time the workstation was defined, that the user's program would be prepared to receive the control byte at the beginning of each record transmitted by this device as the first character of the data. The user's program may, for example, contain special routines to process the nonstandard control bytes.

USING LDEV TO SEND OUTPUT

Output to a device may be sent from a CP-V system to a remote site using the LDEV command. The receiving site may be any type of remote processing terminal. A user may send remote processing output to a device at a site regardless of whether the site is currently connected. If the site is not connected, the output is queued and is sent when the site becomes connected.

To send output to another site, a logical device stream must be directed to an output device at the other site. For example,

```
!LDEV L1,(WSN,BBB),(DEV,LP)
```

The above command directs logical device stream L1 to device LP at the site with workstation name BBB. The file that is to be output may then be written to logical device stream L1 with commands such as

```
!PCL
COPY FILE TO L1
END
```

This example assumes that the output resides in the file called FILE.

The logical file will not actually be queued for output until one of the following occurs:

1. The job exits.
2. The user issues a !PRINT command (available only to on-line users).
3. The logical device stream is modified using the LDEV command. Actually, the user may issue another LDEV command for which the sole purpose is to dispatch the cooperative file for output. The simplest such command would be

```
!LDEV L1
```

which returns the logical device stream L1 to the default attributes defined at SYSGEN, thereby redefining the attributes of L1 and dispatching the current cooperative file for output.

All of the standard LDEV options may be used when assigning output to a remote device if they are legal for the particular device. For example, if the following LDEV command is used

```
!LDEV L1,(WSN,BBB),(DEV,LP),(FORM,WXYZ)
```

this cooperative file will not be output until the form WXYZ is mounted on the device LP at workstation BBB.

The SRCB option on the LDEV command should only be used when the file to be output contains user-supplied control bytes at the beginning of each record. User-supplied control bytes are appropriate only when the programmer wishes to supply control bytes that are different from those supplied by CP-V.

EXAMPLES OF LDEV USAGE

In these examples, R1 is used as the logical device stream name on the LDEV command.

1. Writing to a device:

Assume that a workstation named USA has been defined with a printer named LP. To assign R1 to this device, the LDEV command is

```
!LDEV R1,(WSN,USA),(DEV,LP)
```

If the user wishes to run a program called WOWIE, which prints through M:LL, he might, for example, issue the following commands:

```
!ASSIGN M:LL,(DEVICE,R1) (batch)
!RUN (LMN,WOWIE)
```

or

```
!SET M:LL R1 (R1) (on-line)
!START WOWIE (R1)
!PRINT (R1)
```

The printed output from WOWIE would be sent to the printer LP at workstation USA.

2. Submitting a job from a CP-V system acting as a slave IRBT:

Assume that a CP-V system is slave to another operating system that uses the HASP Multileaving protocol. The master system is known in the slave CP-V system as workstation name MASTER and its card reader is known as device JE (for "job entry"). If a job to be run at the master system has been stored in a file called JOBFIL at the slave system, the job can be submitted to the master system with the following commands:

```
!LDEV R1,(WSN,MASTER),(DEV,JE)
!PCL
COPY JOBFIL TO R1
END
```

Note: The file is not actually read by the card reader JE. However, it is transmitted via remote processing as though it had been read by such a card reader.

The file in JOBFIL should contain job control language that is appropriate for the master system so that the job can be executed correctly.

Another set of commands that can be used to submit a job from a CP-V IRBT to a master system is listed below. This set of commands can only be used if the job to be input resides on cards, the master system is not a CP-V system, and no command within the job being submitted contains a ! in the first column. The entire set of commands must be submitted from the card reader at the CP-V IRBT.

```
!JOB SUBMIT,REMOTE,7
!LIMIT (CORE,8),(TIME,2)
!LDEV R1,(WSN,MASTER),(DEV,JE)
!PCL
COPY CR TO R1
//PROG JOB (28741,SMK=CC),JOHN.SMITH,
// MSGLEVEL=1
// EXEC PGM=PL1COMP
//SYSPRINT DD SYSOUT=A
//COMPOUT DD UNIT=SYSDA,
// DISP=(NEW,PASS),SPACE=(80,250)
//SYSIN DD *
```

[source statements]

```
/*
!EOD
!EOD
END
```

3. Passing files between CP-V systems:

When two CP-V systems are connected together it is possible to pass unstructured data between users at the two sites. Such files are limited to a maximum of 140 bytes per record (a symbiont restriction) and no structure is maintained for keyed files. Therefore, if the user wishes to maintain a keyed structure or if records

longer than 140 bytes exist, the file must be processed by a user-written program to prepare it for transmission. In the example below, the file COMFILE is assumed to be a consecutive file with records that do not exceed 140 bytes in length.

Assume that there are two CP-V systems, A and B. (It is not important which is the master and which is the slave.) B is defined in A as workstation CPVB and has a device named FO (for "files out"). A is defined in B as workstation CPVA and has a device named FI (for "files in") which matches the FO device.

Note: FI and FO probably are not actual physical devices. They are more likely to be pseudo devices for which attributes were defined when workstation CPVA was defined in B and when workstation CPVB was defined in A. The only important factor is that the two devices, whether pseudo or actual, have matching attributes.

If a user in A wishes to pass the file COMFILE to a user in B, he might use the following commands:

```
!LDEV R1,(WSN,CPVB),(DEV,FO),(NAME,XXX)
!PCL
COPY COMFILE TO R1
END
```

XXX is the name that the file carries while it is being passed from one machine to the other. It is not required but allows the user in B to access the file by name.

After the two machines have been connected and the file transmitted between them, a user in B can copy the file to his own version of COMFILE (or to any file) as follows:

```
!LDEV R1,(WSN,CPVA),(DEV,FI),(NAME,XXX)
!PCL
COPY R1 TO COMFILE
END
```

The transfer of the file is now complete.

LDEV PROCESSOR

The LDEV command is available to all on-line and batch users. An M:LDEV program procedure that is almost identical to the LDEV command exists; however, it can only be used for remote processing purposes (i.e., to assign logical device streams to remote devices) by shared processors. (The M:LDEV procedure is described in the CP-V/BP Reference Manual, 90 17 64.) The following discussion is for those users who wish to assign logical device streams to remote devices within the program rather than by use of the LDEV control command.

Any program that has been loaded with the Load processor may call the LDEV processor through use of the M:LINK

procedure. The LDEV processor can then be used to perform the following:

1. Assign a logical device stream to a remote device.
2. Assign a form name to the stream if desired.
3. Specify whether or not the user will supply record control bytes.

The user who wishes to use this facility should follow the steps outlined below.

1. Obtain a common page. This may be done using the M:GCP procedure.

```
M:GCP 1
```

(This should be the only common page currently owned by the program.)

2. Store the following FPT into the first seven words of the page obtained. (The M:GCP procedure returns the start address of the page in register 9.)

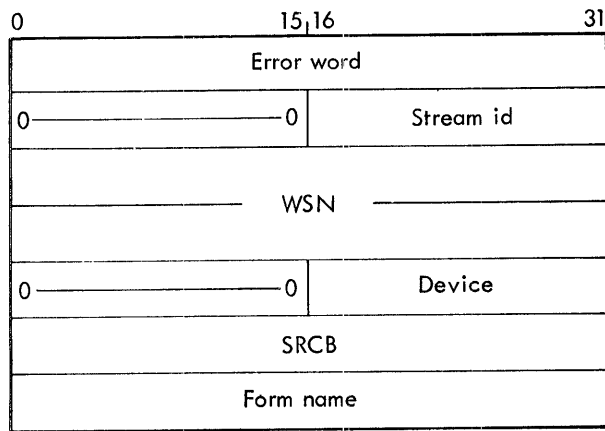

where

Error word may be set to any value by the user. If the LDEV is successful, this field will be set to zero on return from the link. If it is set to any other value, an error occurred.

Stream id specifies, in text format, the name of one of the SYSGEN-defined logical device streams (e.g., L1, P1).

WSN specifies the workstation name in text format, left-justified and blank filled.

Device specifies one of the devices defined for the workstation in text format.

SRCB specifies, if set to zero, that the system should supply record control bytes. If non-zero, it specifies that the user will supply record control bytes.

Form name specifies the form name for the stream. The form name may be one to four characters in text format, left-justified and blank filled. If the field is set to zero, no form name will be associated with the stream.

3. Link to the LDEV processor by using the M:LINK procedure.

```
M:LINK 'LDEV','SYS'
```

LDEV will return to the instruction following the M:LINK procedure using the M:LDTRC procedure. If the first word of the FPT is zero, the LDEV was successful. If an error occurred, the first word of the FPT will be non-zero and LDEV will print an error message through M:LL.

Example:

The following Meta-Symbol code assigns logical device stream L1 to device LP at workstation STATION. The system is to supply record control bytes and the standard form is to be used.

```
M:GCP 1 GET COMMON PAGE
BCS,8 NOPAGE NONE AVAILABLE
STW,9 SAVEPAGE SAVE ADDRESS
LI,1 6
LW,2 FPT,1 MOVE FPT
STW,2 *SAVEPAGE,1
BDR,1 $-2
M:LINK 'LDEV','SYS' CALL LDEV
LW,9 *SAVEPAGE SUCCESS?
BNEZ ERROR
.
.
.
FPT EQU $-1 SKIP ERROR WORD
DATA C'L1' ZEROS AND STREAM ID
TEXT 'STATION' WORKSTATION NAME
DATA C'LP' ZEROS AND DEVICE
DATA 0,0 NO SRCB,NO FORM NAME
```

JOB COMMAND

The JOB command is described in complete detail in the CP-V/BP Reference Manual, 90 17 64. Only that portion of the command that applies to remote processing, the wsn option, is described here. The format of the JOB command is

```
JOB account,name[(ext. acctg.)][, priority][,wsn]
```

where wsn may specify either a workstation name or the term LOCAL which specifies "the site at which the job is run". Although the effect of the wsn field on the JOB command is rather complex, the general effect is simple: the job's print and punch output is directed to the named workstation.

If a workstation name is specified and is valid, the following steps are taken:

1. If a system listing device is defined for the specified workstation, logical cooperative stream L1 is assigned to that device. In effect, it is exactly as though the user had issued the command

```
!LDEV L1,(WSN,wsn),(DEV,xx)
```

where wsn specified the workstation name that is on the JOB command and xx specified the name assigned to the system listing device.

The user may change the device assignment for L1 within his job using LDEV and thereby nullify the effect of the wsn on the JOB command for print output.

If a system listing device is not defined for the workstation, L1 maintains its default assignment that was determined at SYSGEN unless the assignment is explicitly changed within the job by the LDEV command.

For RBTs, the printer is automatically designated as the system listing device. For IRBTs, a listing device may be selected to be the system listing device when the workstation is defined using Super.

2. If a system punch device is defined for the specified workstation, logical cooperative stream P1 is assigned to that device. In effect, it is exactly as though the user had issued the command

```
!LDEV P1,(WSN,wsn),(DEV,xx)
```

where wsn specified the workstation name that is on the JOB command and xx specified the name assigned to the system punch device.

The user may change the device assignment for P1 within his job using LDEV and thereby nullify the effect of the wsn on the JOB command for punch output.

If a system punch device is not defined for the workstation, P1 maintains its default assignment that was determined at SYSGEN unless the assignment is explicitly changed within the job by the LDEV command.

For RBTs, the punch is automatically designated as the system punch device. For IRBTs, a punch device may be selected to be the system punch device when the workstation is defined using Super.

If the term LOCAL is specified in the wsn field of the JOB command, the job's origin is ignored and L1 and P1 maintain their default assignments established at SYSGEN unless they are explicitly changed within the job using LDEV.

If a workstation name is specified but is not valid, the diagnostic output is sent to the submitting site and the job is aborted.

If there is no wsn specified on the JOB command and the job originated at the central site, L1 and P1 maintain their default assignments established at SYSGEN unless they are explicitly changed within the job using LDEV.

If there is no wsn specification on the JOB command and the job originated at a remote site, then print and punch output are to be returned to the originating remote site and, in effect, it is exactly as though the user had specified his own wsn on the JOB command.

THE ISCL PROCESSOR

The ISCL processor provides the on-line or batch user with the ability to copy, create, list, or delete files in another CP-V system via an IRBT connection. The processor interprets the user ISCL command and packages it for transmission to the remote CP-V system, where the action is performed asynchronously. Notification of completion of service (or cause of failure if a failure occurs) and return of information requested occurs in the user MAILBOX file through messages placed there by RATLER, a system ghost job. When the user requests that a local file be sent to a remote file, the local portion of the service is performed immediately by the ISCL processor. When the file is built in the remote CP-V system, a message indicating addition of a file to the remote account is placed in the MAILBOX file of the remote account.

To use the ISCL processor, the user must be authorized at the remote site as well as the local site. The ISCL processor is called via the command:

```
!ISCL
```

User requests may be of the following types:

- Copy a file from a file at a remote CP-V system.
- Send a file to a file at a remote CP-V system.
- Delete a file at a remote CP-V system.
- List file(s) which are at a remote CP-V system.

ISCL COMMANDS

ISCL commands have the following general structure:

```
command-verb  fid-list [ { ON } fid-list ]  
                { TO }  
                { OVER }
```

The command-verbs are described below. Some of the commands allow the preposition specification, but it is never required. The general format of a fid-list is:

```
fid[, fid]...[@wsn]
```

The fid must be specified as

filename [.[account]][.password]]

The default account is the user's account and the default password is no password. In the SEND command, the default fid to the right of the preposition is the fid specified to the left of the preposition. The preposition OVER is assumed.

The qualifier '@wsn' designates the file as a remote file at the site specified by the workstation name 'wsn'. Only one wsn specification is permitted in a command line. If multiple file specifications are appropriate (only in the LIST and DELETE commands), the wsn specification follows that last fid specification.

Each subfield of a fid specification (filename, account, and password) may be expressed in the usual form or in one of the following three ways:

1. In quotes ('ACCT203').
2. As a character string (C'MYFILE').
3. As a hexadecimal string (X'123456789ABCDE0').

An example of an appropriate file identification is:

'FILEN@ME' .X'C1C3C3E3' .C'PASSWORD'

Note that the file's name is FILEN@ME.

The ISCL commands are described in the paragraphs below.

COPY A FILE FROM A REMOTE CP-V SYSTEM

SEND This command specifies that a remote file is to be written over or onto a local file. The format of the command is

$$S[END] \text{ fid1 } \left[\begin{array}{l} \text{ON} \\ \text{TO} \\ \text{OVER} \end{array} \right] \text{ fid2}$$

The qualifier '@wsn' is required within the fid1 specification. A MAILBOX message at the local site will signify that the transmission is complete. If ON or TO is specified and fid2 already exists, an error message will be issued.

Examples:

1. S FILE.AAAA@CPV1 ON MYFILE

The file FILE in account AAA at site CPV1 will appear on file MYFILE at the local site.

2. SEND XXXX.YYYY@CPV99

The file XXXX in account YYYY at site CPV99 will be copied onto file XXXX in the user's account at the local site.

SEND A FILE TO A REMOTE CP-V SYSTEM

SEND This form of the SEND command specifies that a file at the local site is to be written over or onto a file at a remote site. The format of the command is

$$S[END] \text{ fid1 } \left[\begin{array}{l} \text{ON} \\ \text{TO} \\ \text{OVER} \end{array} \right] \text{ fid2 } @wsn$$

This command requires the '@wsn' qualifier whether or not a fid2 specification is given. The MAILBOX file of the target account at the remote site will receive notification of the completion of service. The user who originates the command will not receive any notification of completion of service.

Examples:

1. SEND C'@@@' .AAAA.SECRET OVER FILECOPY. SECURITY@CHICAGO

The file @@@ in account AAA with the password SECRET will be sent to the CHICAGO site as file FILECOPY in the user's account with the password SECURITY.

2. S XXX OVER @SIGMA7

The file XXX from the user's account will be transmitted to site SIGMA7 and will overwrite file XXX in the user's account there.

DELETE A FILE AT A REMOTE CP-V SYSTEM

DELETE This command deletes a file or set of files at a specified remote site. The format of the command is:

$$D[ELETE] \text{ fid-list} @wsn$$

A MAILBOX message in the user's account at the local site will indicate completion of service.

Example:

D FILE,XXX.YYYY@CPV33

The files FILE in the user's account and XXX in account YYYY will be deleted at the remote site CPV33.

LIST A FILE AT A REMOTE CP-V SYSTEM

LIST This command lists at the local site the file parameters of a requested file (or set of files) which are at a remote site. The format of the command is:

$$L[IST] \text{ fid} \left[\begin{array}{l} \text{A} \\ \text{EA} \end{array} \right] [, \text{fid} \left[\begin{array}{l} \text{A} \\ \text{EA} \end{array} \right]] . . . @wsn$$

ISCL MESSAGES

If option A has been requested, the attributes of each file are also listed. These attributes include

- Size in granules.
- Record count.
- Organization (keyed or consecutive).
- Read accounts, if other than 'ALL'.
- Write accounts, if other than 'NONE'.
- Modification date.

If option EA (extended attributes) has been requested, the following attributes are listed in addition to those described above:

- Creation date.
- Expiration date.
- Backup date.
- Last access date.

If the filename is omitted in any fid specification, the entire account is listed according to the A or EA specified. If neither A nor EA is specified, the default is A for a single file listing and just filename if an entire account is being listed.

Listing information appears in the MAILBOX file in the user's account at the local site.

Examples:

1. L XXX.YYYY(EA)@SIGMA7

The file XXX in account YYYY at site SIGMA7 is examined and the extended attributes of that file are returned to the local user's MAILBOX file.

2. L XXX(A),.YYYY,.BBBB(A)@CPV1

The file XXX in the user's account and all files in the account BBBB will be listed with attributes and the names of all files in account YYYY will be listed. All files examined reside at the remote site specified by the workstation name CPV1.

The messages listed in Table 2 are error messages produced by ISCL in regard to the last request entered. (System error messages and messages from the processor which handles LDEV commands can also be received while using ISCL commands.) Table 3 lists those messages that can appear in MAILBOX files as a result of an ISCL request.

RECORD SIZE RESTRICTIONS

The following record size restrictions apply to records written to and read from devices at remote sites:

1. No output record is allowed that exceeds the maximum set for the device when the workstation is defined. Records are truncated if they exceed the maximum. The maximum record size for input devices is currently not used.
2. If a record is written through a DCB that specifies the DATA or TABS options, the record length cannot exceed 136 bytes after the options have been processed. Records are truncated to enforce this rule.
3. Records that are smaller than the minimum defined for the device when the workstation was defined are automatically expanded to the minimum size with blanks or zeros, depending on the mode (BIN/BCD) of the DCB being used for output devices. Note that this is a handy feature when data should appear to the remote site to be in 80-column card format.
4. Records received by the CP-V remote processing system may not exceed 140 bytes in their uncompressed form. In some cases, this limits the data to 139 bytes since a record control byte exists. (This is an important consideration when passing data files between CP-V systems.)

Table 2. ISCL Error Messages

Message	Description
FILE EXISTS – CANNOT COPY	ON or TO was specified in a request to write a local file which exists. OVER must be specified to allow overwriting.
FILE PARAMETERS INCOMPLETE	The file specified to be sent has a malformed set of file parameters.
ILLEGAL COMMAND	The command does not contain all necessary information.
NOT YOUR FILE	An attempt was made to write a file to which the user is denied write access.
OUT OF PAGES	ISCL was unable to obtain another page due to system or user core limits. Check the user's authorization.

Table 3. MAILBOX Messages

Message	Description
.. DELETING FILE	This message occurs when a DELETE request was given. It is followed by the name of the file for which deletion was requested and a message which indicates either that the deletion was successful or an error occurred.
.. LISTING FILE	Same as above except that it pertains to a LIST request.
..SENDING FILE	Same as above except that it pertains to a SEND request.
..n FILES DELETED	The number of files indicated by n have been successfully deleted.
..n FILES LISTED	The number of files indicated by n have been successfully listed.
HAVE SENT: filename	The specified file has been successfully sent.
CANT GET PAGE	The system or ghost core limits have been exceeded for the centralized processing ghost RATLER.
CLOBBERED FILE PARAMETERS	The designated file has a malformed set of file parameters.
FILE EXISTS – CANNOT COPY	An attempt was made to write a file to which the user is denied write access.
TRANSMISSION ERROR	One or more records have been lost in transmission of a file or a request.
NOT AUTHORIZED IN REMOTE SYSTEM	The user does not have proper authorization in the designated remote system.

VERTICAL FORMAT CONTROL AT REMOTE PRINTERS

The vertical format control (VFC) available for printers at RBTs and at IRBTs differs somewhat from that for printers at a CP-V system.

7670 RBT PRINTERS

The M:DEVICE VFC CAL may be used for printer format control. The same horizontal control available for a local printer is available for the 7670 RBT printer. However, only two types of vertical control may be requested by the user:

1. Skip n extra lines before printing (X'Cn').
2. Perform top-of-form before printing (X'F1').

The 7670 RBT printer will also perform top-of-form or vertical tab after a line is printed if X'0C' or X'0B', respectively, is contained within the text of the output message.

IRBT PRINTERS

The VFC codes sent to IRBT listing devices differ according to the SRCB type specified for the device when the workstation was defined by the system manager.

SRCB=C

All records are single spaced regardless of the VFC codes used.

SRCB=P or SRCB=X

The following codes are available:

- X'60' - suppress space before printing.
- X'Cn' (n=0-F) - skip n extra lines before printing.
- X'Fn' (n=0-F) - skip to channel n before printing.

All other codes are translated in the following manner:

If bit 3 of the code is set to zero, the code is treated as though it were an X'Cn' type code. If bit 3 of the code is set to one, the code is treated as though it were an X'Fn' type code.

SRCB=U

When SRCB=U, the user can supply his own VFC code. Standard HASP Multileaving codes follow the eight-bit format described below (however, not all IRBT printers will use all codes appropriately):

- 101000nn - space nn immediately.
- 1011nnnn - skip to channel nnnn immediately.
- 100000nn - space nn after printing.
- 1001nnnn - skip to channel nnnn after printing.
- 10000000 - suppress space.

PASSING FILES DIRECTLY TO CP-V IRBT PRINTERS

When noncontrol input files are received at a CP-V IRBT from Multileaved systems and are to be directly passed to

a print device with SRCB=P, the Multileaved VFC codes are translated and placed in the first character position of the input records.

2780 RBT OR 3780 RBT PRINTERS

The VFC codes for 2780 RBT printers are treated like those for IRBT printers with SRCB=P (see above), with the following exceptions:

1. Suppress space is not allowed. X'60' will be treated as X'C0'.
2. Skip to channel may only specify channels 0-7; higher numbers will have eight subtracted from them.

3. REMOTE OPERATOR

Since CP-V supports a variety of remote terminals, the operation of remote terminals is a very broad subject. Each remote operator should read the operations manual written by the manufacturer of his particular remote terminal. In addition, IRBT and 2780 operators should read Appendixes A and B and 7670 RBT operators should read Appendixes A and C. Operators at a CP-V system that is acting as an IRBT should also read Chapter 4. All operators at remote sites should read this chapter because the information applies to operation of both RBTs and IRBTs.

This chapter describes remote processing control commands that are available to the operator at the remote site. In some cases, the user may act as operator and will supply these commands himself. The procedures for changing the form at a remote output device and for entering an input file that is not to be scanned for control commands are also described. Error and informational messages that apply to remote processing are listed at the end of the chapter.

REMOTE PROCESSING CONTROL COMMANDS

There are several control commands (RBCCs) unique to the remote processing system. These control commands have several common characteristics.

1. They usually begin with the prefix IRB. If they are transmitted to CP-V from the operator's console of an IRBT, the prefix IRB need not be present. For example,

From card reader: IRBCONT LP

From operator's console of an IRBT: CONT LP

2. They may be submitted from any input device defined to be a control device or the OC device.
3. They may appear in a job stream anywhere except within a job or after a FIN card. (The RBID command, discussed shortly, is an exception to this rule.)
4. The characters "." and ";" are treated as an end of card and may be followed by a comment. The comment can extend only to the end of the card.

The remote processing control commands are described in the following paragraphs under the headings "General Commands", "File Handling Commands", and "Device Commands".

GENERAL COMMANDS

These commands are used to log workstations on and off and to transmit messages to the local operator.

RBID Logs a workstation onto the system. (See Appendix B.) No other cards may precede or follow the RBID card. (Other cards may be input only after the log-on process is complete.) The form of the RBID control command is

```
IRBID wsn [message]
```

where

wsn must be a one- to eight-character workstation name authorized by system management.

message is any message that the user wishes to send to the local operator. The message can only extend to the end of the card.

RBDISC Logs the workstation off the system. All output ready for the workstation is transmitted to it and the line is then disconnected. The form of the command is

```
IRBDISC
```

RBXXX Logs the workstation off the system and disconnects it immediately. All output in progress is saved for the next session and all input in progress is discarded. The format of the command is

```
IRBXXX
```

RBMSG Transmits a message to the local operator. The form of the RBMSG control command is

```
IRBMSG message
```

The message can only extend to the end of the card. Therefore a lengthy message may require more than one RBMSG control command.

RBDEV Displays the status of all devices at the workstation and, where applicable, the name of the form mounted on each device. The format of the command is

```
IRBDEV
```

RBINFO Displays various CP-V statistics. The format of the command is

```
!RBINFO
```

The format of the output is

```
*TIME = hh:mm mo/dd/yy
*USERS IN SYSTEM = nn
*ETMF = e
*BATCH JOBS: RUNNING = j
*           WAITING = i
```

where ETMF specifies the execution time multiplication factor. The user may multiply the amount of CPU time required for a task by the ETMF to estimate the elapsed time required to complete the task in the current environment.

FILE HANDLING COMMANDS

These commands control individual files belonging to a workstation or all of the files for that workstation. They take effect regardless of whether the affected files are currently in an input stage, an output stage, or are running.

RBPRIO Changes the priority of the workstation's files in the symbiont system to the specified priority. The command has the form

```
!RBPRIO priority [ , { ALL
                  , sysid [, sysid] . . . } ]
```

where

priority specifies the new priority of the files that are to have their priority changed. Any priority in the range 1-F is legal for output files and any priority in the range 0 to the value specified for RP (an option in the WORKSTATION command) is legal for input files.

ALL specifies that all of the workstation's files that are in the symbiont system are to have their priorities changed. ALL is the default.

sysid is a number that identifies a file for which the priority is to be changed.

RBHOLD Prevents current output files and output files from other sources from being output, but does not affect input files (except that output that results from the execution of such files is held). Its primary purpose is to allow

the input, execution, and output of a high priority job (or series of jobs) after which output of held files may then be resumed. The form of the RBHOLD control command is

```
!RBHOLD [ ALL
         , sysid [, sysid] . . . ]
```

where

ALL specifies that all output files for the workstation are to be held. A "hold all" flag is set causing the output from all files transferred from other sources to this workstation to be held also. Any jobs submitted from this workstation following an !RBHOLD ALL are not held. Only those jobs submitted from this workstation before the !RBHOLD ALL and all files transferred from other sources before and after the !RBHOLD ALL are held. ALL is the default.

sysid is a number that identifies a file to be held.

RBRETRIEVE Releases files that are held. The form of the RBRETRIEVE control command is

```
!RBRETRIEVE [ ALL
             , sysid [, sysid] . . . ]
```

where

ALL specifies that all files that are held are to be released for output. The "hold all" flag is reset. ALL is the default.

sysid is a number that identifies a file to be released for output.

RBDELETE Deletes input, output, or executing files from the symbiont system. If a file is deleted when it is running, it is aborted and the output is released. The form of the RBDELETE control command is

```
!RBDELETE [ ALL
          , sysid [, sysid] . . . ]
```

where

ALL specified that all files are to be deleted. ALL is the default value.

sysid is a number that identifies a file to be deleted.

RBSTATUS Requests the status of files belonging to the workstation. The status is returned in the message file (see "Remote Processing Messages"). The form of the RBSTATUS control command is

```
IRBSTATUS [ALL
           [sysid[,sysid], . . .]
```

where

ALL specifies that the status of all files be given. **ALL** is the default value.

sysid is a number that identifies a file for which the status is to be given.

RBSWITCH Changes the workstation assignment of output files. Files cannot be switched until they have completed running. The command has the form

```
IRBSWITCH wsn [ , [dev] [ , {ALL
                  [sysid[,sysid], . . .} ] ] ]
```

where

wsn is the name of the workstation to which the files are to be switched. The central site has the wsn **LOCAL**.

dev specifies any device name defined for the workstation. The device must exist at both workstations.

ALL specifies that all files are to be switched. **ALL** is the default. (Only files for devices which exist at both workstations are switched.)

sysid is a number that identifies a file or set of files to be switched.

The remote processing system will switch all files possible and will produce an error message when any of the following conditions occurs:

1. A specified file cannot be found.
2. There is no file for the appropriate device for the specified sysid.
3. The specified device does not exist at both workstations.
4. An attempt is made to switch a file more than once.

Note that when dev is not specified, both commas are required in the command syntax. For example

```
IRBSWITCH NORTHLAB,,1A2,3BC
IRBSWITCH NORTHLAB,,
```

DEVICE COMMANDS

These commands control the devices at a workstation. In the command formats, "dev" specifies the name of a device defined for the workstation. For RBT workstations, they are

- CR – card reader
- CP – card punch
- LP – line printer

SUSPEND COMMAND

RBSUSPEND Specifies that output on the specified device(s) is to be suspended. The command is only valid for IRBTs. (See Appendix B for a discussion of suspending output on a 7670 RBT device.) Devices suspended with RBSUSPEND can be restarted with RBCONTINUE, RBREPRINT, RBABORT, RBSAVE, or RBALIGN. The format of the RBSUSPEND command is

```
IRBSUSPEND dev[,dev]. . .
```

RESTART COMMANDS

These commands may be issued for any active or suspended output device at an IRBT or for any 7670 RBT output device that has been suspended by the RBT operator (see Appendix B). The dev option need not be present if the command is sent from an RBT.

RBCONTINUE Specifies that suspended output is to be continued from where it stopped. The following should be noted.

1. If the command is from an IRBT and a device is specified which is not suspended, no action is taken on that device.
2. If the command is from a 7670 RBT and output was suspended by pressing GENERAL CLEAR on the RBT control panel, one or two lines of output may be lost.
3. RBCONTINUE cannot be used at an IBM 2780 or 3780 RBT.

The format of the RBCONTINUE command is

```
IRBCONTINUE [dev [,dev]. . .]
```

RBREPRINT Specifies that the output is to be restarted at the symbiont retry point (see glossary). The form of the command is

```
IRBREPRINT [dev [,dev]. . .]
```

RBABORT Specifies that the output should be stopped and deleted from the system. The form of the RBABORT command is

```
IRBABORT [dev[,dev]...]
```

RBSAVE Specifies that the output should be put back in the output symbiont queue and returned starting at the symbiont retry point (see glossary) when it is again selected according to priority. If KEEP was specified by the system manager for this device, or the file being output is not in its last copy, RBSAVE will requeue the entire file from the beginning of the current copy. (For message files, RBSAVE is equivalent to RBABORT.) The form of the RBSAVE command is

```
IRBSAVE [dev[,dev]...]
```

RBALIGN Specifies that forms alignment should be performed on the device(s) specified. This command may also be used to unlock a device (as in the RBUNLOCK command below) and thus align the beginning of a file. The format of the command is

```
IRBALIGN [dev[,dev]...]
```

OTHER DEVICE COMMANDS

RBLOCK Locks out the specified device(s) from further use. Any current operation on the device is completed before the lock takes effect. The OC device at an IRBT cannot be locked out. The format of the command is

```
IRBLOCK dev[,dev]... . .
```

RBUNLOCK Unlocks a locked device. (The RBALIGN command may also be used to unlock a locked device.) The form of the RBUNLOCK command is

```
IRBUNLOCK dev[,dev]... . .
```

RBFORM Specifies the form name to be associated with a device. Each output symbiont file has a form name associated and will not be output unless the appropriate form is

specified for the device via RBFORM. The remote operator is informed each time there is a file in the system that could be output if the form for a device were changed. If RBFORM is issued for a noncontrol input device, the form name becomes the name of the next file entered from the device. The RBFORM command is always legal for input devices. It is only legal for an output device if the device is either inactive or locked. The format of the RBFORM command is

```
IRBFORM dev[,name]
```

where name is the form name. If it is omitted, the standard form for the device is assumed.

RBSIZE Controls various parameters associated with RBT hardware and has the form

```
IRBSIZE option[,option]... . .
```

where the options may be

LP=value sets the maximum length of lines printed at the RBT.

CP=value sets the maximum length of card images punched at the RBT.

NOEM specifies that EM characters are not to be punched into cards at the RBT. If NOEM is specified, the full 80-column image will be punched for all cards.

EM specifies that EM characters may be punched into cards at the RBT.

The maximums and defaults for the above options are established when the workstation is defined (via the Super WORKSTATION command).

RBCTL Changes the device on which system messages will appear from that which is defined as the system message device for the workstation and is only applicable to IRBTs. The format of the command is

```
IRBCTL devname
```

where devname may be OC or any other output device for which SRCB=P. (SRCB=P is specified when the workstation is defined.) If the device is not OC, system messages will be in the form of message files.

CHANGING FORMS

When output for the form currently mounted on an output device at a remote site is exhausted but files for the device with other form names exist, the following message is output on the system message device at the remote site:

```
*SETUP REQUIRED DEV=xx
```

where xx specifies the name of the device (e.g., LP).

Note that message files use the standard form and are not output when the system message device itself has a non-standard form mounted. Therefore remote operators should use standard forms on system message devices as much as possible. The above message, for example, might not be output when needed if a nonstandard form were mounted on the system message device.

When the SETUP REQUIRED message is output, the remote operator should follow the procedure below to change the form:

1. Find out what new forms are needed for files waiting to be output. This is accomplished by using the RBSTATUS ALL command. (Files that are listed with no form name require the standard form.)
2. Lock the device using the RBLOCK command.
3. Select the next form stock to be used.
4. Mount the appropriate form stock on the device.
5. Inform CP-V that the form is ready by using the RBFORM command.
6. Unlock the device. This may be done via the RBUNLOCK command or the RBALIGN command if alignment is required.

Note: RBALIGN is illegal from 2780 RBTs.

All files for the form just mounted will now be output.

If the RBALIGN command is used, the banner and one page of output will be printed. Then the device will be suspended. The operator should align the form if necessary and then enter one of the following commands to restart the symbiont:

RBCONT — the form was properly aligned; continue.

RBREPRINT — the form alignment has been corrected; start over from the beginning of the file.

RBALIGN — the form has been realigned; check it for alignment again.

When both the master and slave systems are CP-V systems, forms management is performed automatically.

ENTERING A NONCONTROL INPUT FILE

A noncontrol input file is a file that is not to be scanned for control commands. A noncontrol input file can be entered from either a noncontrol device or a control device. (Devices are defined as noncontrol or control when the workstation is defined by the system manager.)

If a noncontrol input file is to be entered from a noncontrol device, the operator need only start the device to read the file. (A control input file cannot be entered from a noncontrol device.)

If a noncontrol input file is to be entered from a control device, the file must be preceded by the command

```
!!NCTL [name]
```

where name specifies the one- to four-character name of the noncontrol input file.

If the input file is to be given a name by the operator or if the name on the !!NCTL command is to be overridden by the operator, the operator should use the RBFORM command. The RBFORM command may be entered before or during (but not after) input of the file. When the RBFORM command is issued for a noncontrol device (or one that is effectively a noncontrol device due to the !!NCTL command), the form name becomes the name of the next file received from the device. Thus,

```
!RBFORM CR, SAM
```

applies the name SAM to the next noncontrol input file received from the card reader at the workstation.

2780 RBT ERROR RECOVERY

The CP-V system provides for recovery from device failure at a 2780 RBT (e.g., card jam, out of paper). When the card reader operation is interrupted, the remote operator need only correct the situation causing the interruption and continue from the point of interruption. Some part of a card deck must then be entered to terminate input. (A !FIN card would suffice.)

For output device failure, the remote operator must correct the condition and then must submit an input deck before the output operation will resume. Any of the control commands listed in this chapter (with the exception of RBCONTINUE) may be entered. When some form of input has been received from the 2780 RBT, output operation will once again be available at the RBT.

Note that it is necessary to submit some form of input in both input and output types of recovery conditions. Failure to do so will result in discontinuance of normal operation.

REMOTE PROCESSING MESSAGES

The messages described in Tables 4 and 5 are those produced by the remote processing system on the system message device of the remote terminal. Those in Table 2 are general remote processing messages. The messages in Table 3 are issued by the ISCL and RATLER processors. (See the ISCL processor description in the previous chapter.)

Table 4. Remote Processing Messages

Message	Description					
*ABOVE CC UNRECOGNIZED OR ILLEGAL – SKIPPED	The remote processing control command listed above is unknown or not legal at this time.					
*BAD RBSWITCH: ILLEGAL WSN OR SWITCH TYPE	An RBSWITCH command contains an error. The command is aborted. The command in error is listed above this message and the field in error is flagged with an asterisk.					
*CARDS FOLLOWING FIN/RBID IGNORED	One or more records following a FIN record or an RBID record were ignored. (The remote site hardware reads the records, but the system ignores them.) This message is output any time a FIN is sent from an IRBT regardless of whether or not records follow the FIN.					
**CC ERROR: BAD OPTION(\$), SYNTAX(#), OR VALUE(*)	Errors were found in fields of an RBSIZE command. Those options not in error were accepted. The RBSIZE command is listed above this message and the fields in error are flagged using the notation indicated in this message.					
**CC FIELDS BAD: ILLEGAL(#), NON EXISTENT(*), OR NOT YOUR (\$) SYSID	This message is printed when one or more sysids on a remote processing control command cannot be processed. The command is listed above this message and the sysids in error are flagged using the notation indicated in this message. Those sysids not flagged are processed normally. If the command was RBSWITCH, a \$ or an * may flag a good sysid of the wrong device type.					
**CC FIELDS BAD: ILLEGAL(#), UNKNOWN(*), OR INVALID DEVNAME	This message is printed when one or more device names on a remote processing control command cannot be processed. The command is listed above this message and the device names in error are flagged using the notation indicated in this message. Those devnames not flagged are processed normally.					
*DEV = yy <table style="display: inline-table; vertical-align: middle;"> <tr><td rowspan="4" style="font-size: 2em; vertical-align: middle;">}</td><td>ACTIVE</td></tr> <tr><td>INACTIVE</td></tr> <tr><td>SUSP'ED</td></tr> <tr><td>LOCKED</td></tr> </table> [FORMS = name]	}	ACTIVE	INACTIVE	SUSP'ED	LOCKED	These messages are produced, one for each device, in response to the RBDEV command. yy is the name of the device and name specifies the name of the form on the device.
}		ACTIVE				
		INACTIVE				
		SUSP'ED				
	LOCKED					
**ILLEGAL FORMS CHANGE	An RBFORM command referred to a currently active output device.					
*JOB ABORTED	The job was not accepted for processing because of errors in the JOB or LIMIT commands. The commands in error are listed with appropriate error messages.					
*JOB ACCEPTED	A job has been received and the JOB and LIMIT cards do not contain errors. The job has been accepted for processing.					
*MISSING JOB COMMAND – JOB IGNORED	The first command of a job was not a JOB command. The job is deleted. The system will continue reading commands and other legal jobs in the job stream will be processed.					

Table 4. Remote Processing Messages (cont.)

Message	Description
MSG text	This message was sent by the central site operator.
*NO :SYS AUTHORIZATION – JOB DELETED	A job with account :SYS was submitted and the workstation is not authorized to use the :SYS account.
*PRIORITY OF JOB > STATION MAX – SET TO MAX	The priority of a job submitted from a workstation exceeds the maximum set by the system manager for that workstation. The priority is reduced to the workstation's maximum and the processing of the job continues.
*PUNCHED OUTPUT READY – PRESS 'SIGNAL REMOTE' WHEN READY TO PUNCH	Files of punched output are waiting in the output queue for the workstation. This message applies only to 7670 RBTs.
*SETUP NEEDED DEV=xx	There are no more output files for the form currently mounted on the device but files could be output if the form name were changed with RBFORM.
STATUS: NO FILES IN SYSTEM	The RBSTATUS command was given with ALL either assumed or specified and no files exist for the workstation.
*SYSID=xxxx DEVICE=xx NAME=filename INPUT FILE ACCEPTED	A noncontrol input file with the name specified by NAME has been accepted from the workstation. If NAME=0000, the file has no name. This message is <u>not</u> output when a file is passed directly to a local device.
<pre> SYSID=xxxx [DEV=xx #GRANS=nnn COPIES=nnn FORMS=nnn HELD DEV=xx #GRANS=nnn COPIES=nnn FORMS=nnn WAITING DEV=xx #GRANS=nnn COPIES=nnn HELD DEV=xx #GRANS=nnn COPIES=nnn WAITING RUNNING RUNNING – OUTPUT WILL BE HELD WAITING yyyy TO RUN WAITING yyyy TO RUN – OUTPUT WILL BE HELD] </pre>	<p>These messages are produced in response to an RBSTATUS control command or at the time a workstation logs on. The messages give the status of the file identified by xxxx and are self-explanatory. xx is the name of the device, nn is the name of the form, and yyyy is the number of jobs ahead of job xxxx in the input queue of jobs waiting to be executed. The messages may appear singly or in a group, depending on the number of files for the workstation. (One message is produced for each file for the workstation.) The single message or group of messages is preceded by the line</p> <p style="text-align: center;">*****STATUS*****</p> <p>and is followed by a line of asterisks.</p>
*SYSID=xxxx **image of job command	This message acknowledges receipt of a job.
<pre> *TIME = hh:mm mo/dd/yy *USERS IN SYSTEM = nn *ETMF = e *BATCH JOBS: RUNNING = j * WAITING = i </pre>	These messages are produced in response to the RBINFO command. ETMF specifies the execution time multiplication factor. The user may multiply the amount of CPU time required for a task by the ETMF to estimate the elapsed time required to complete the task in the current environment.

Table 4. Remote Processing Messages (cont.)

Message	Description
(TOF)***CARD READ NOT IRBID – CANNOT LOG YOU ON I (TOF)	An attempt to log on was made and the input card did not contain an RBID control command. This message applies only to 7670 RBTs.
(TOF)*****CP-V REMOTE BATCH AT YOUR SERVICE – LOGON PLEASE! *****(TOF)	This message is sent to the remote site when it is first connected to the system and following unsuccessful attempts to log on. This message applies only to 7670 RBTs.
(TOF)***ILLEGAL WORK STATION NAME – CANNOT LOG YOU ON! (TOF)	An attempt to log on was made and the workstation name on the RBID control command is not authorized. This message applies only to 7670 RBTs.
(TOF)***INSUFFICIENT STREAMS – CANNOT LOG YOU ON! (TOF)	An attempt was made to log on and there are not enough streams available for the devices at the terminal. Contact the central site for advice. This message applies only to 7670 RBTs.
(TOF)*****yyndd RBID =nnn – WSN **operator message	This is the standard heading produced as the first message of all message files, where yyndd is the device name of the DSC to which the workstation is connected. nnn is a number associated with the WSN for monitor purposes. operator message is the message broadcast to remote sites by the central site operator. It is optional.
(TOF)***WORKSTATION NAME IN USE – CANNOT LOG YOU ON! (TOF)	The WSN specified is already logged on to the system or is LOCAL. Only one remote site at a time can use a given WSN. This message applies only to 7670 RBTs.
*****wsn LOGGED ONTO DSC yyndd AS RBID nnn	This is a log-on confirmation and is sent to the remote site after log-on, where wsn is the workstation name. yyndd is the device name of the DSC to which the workstation is connected. nnn is a number associated with the WSN for monitor purposes.
-wsn – LOGGED OFF	This message informs the user that he is logged off and will now receive all possible output and be disconnected. wsn is the workstation name.

Table 5. ISCL/RATLER Messages to the Remote Operator

Message	Description
RATL. :SYS ERR	An error condition exists with the RATL file in :SYS. Also, if the file does not exist, this message will be issued. RATLER aborts following this message.
BAD WSN: wsn	An inappropriate workstation name has been specified in the RATL file.

4. CENTRAL SITE OPERATOR

There are several central site operator key-ins that pertain to remote processing and several remote processing messages that may be output on the central site operator's console.

These are described in the CP-V/OPS Reference Manual, 90 19 65. For the sake of completeness, these key-ins and messages are listed in this manual in Tables 6 and 7.

Table 6. Central Site Operator Key-Ins

Key-In	Function
DISP[LAY] RBT	Lists the status of each Data Set Controller (DSC) on the operator's console.
RBBDCST message	Adds a message to the remote processing message file that is printed at all remote terminals. "Message " is the text the operator wishes to transmit. The current message is deleted if RBBDCST is immediately followed by a new line (NL) character.
RBCOM, $\left\{ \begin{array}{l} \&RBn\ddot{d} \\ wsn \end{array} \right\} \text{text}$	Transmits control commands from a slave CP-V system to a master system site. RBn \ddot{d} or wsn specifies the Data Set Controller or workstation name, respectively, of the master system; "text" represents any control command relevant to the master system. If the RBn \ddot{d} form is used, it must be preceded by an &. In CP-V to CP-V communications, operators at both systems (the slave and the master) may use RBCOM.
RBDISC $\left\{ \begin{array}{l} \&RBn\ddot{d} \\ wsn \end{array} \right\}$	Disconnects any terminal using DSC RBn \ddot{d} or the terminal being used by the specified wsn. If the RBn \ddot{d} form is used, it must be preceded by an &.
RBLOG RBn \ddot{d} [,wsn]	Allows the specified terminal to log-on automatically. When the automatic log-on is in effect, the remote site user need not submit the !RBID card; his terminal will automatically be logged on as soon as the transmission line is connected. If the wsn parameter is missing, this key-in will cancel the previous RBLOG key-in if one was made, and any RBLOG key-in cancels an automatic log-on workstation name defined for the line at SYSGEN. This key-in may only be issued when the line is not connected; it is required on connections for which the Sigma system is operating as slave to another system if a wsn was not specified at SYSGEN.
RBS $\left\{ \begin{array}{l} \&RBn\ddot{d} \\ wsn \end{array} \right\}$	Allows the named terminal (or all currently disconnected terminals if none is named) to be reconnected following an RBX or ZAP key-in or ERROR MAX disconnect. If the RBn \ddot{d} form is used, it must be preceded by an &.
RSEND $\left\{ \begin{array}{l} \&RBn\ddot{d} \\ wsn \end{array} \right\} \text{message}$	Sends a message file directly to a specific terminal, as identified by RBn \ddot{d} or wsn. If the RBn \ddot{d} form is used, it must be preceded by an &. The message file will be the next file output to the named terminal. RSEND is only legal for terminals that are logged on.

Table 6. Central Site Operator Key-Ins (cont.)

Key-In	Function
RBSWITCH wsn ,devname ,sysid	Allows the operator to switch output files from one workstation to another. wsn is the workstation name that is to receive the file, sysid is the id of the job that output the file, and devname is the device type and must exist at both the sending and receiving sites. Remote processing files may be switched to central site devices by specifying LOCAL as the wsn.
RBX {&RBnidd wsn }	Disconnects a terminal using DSC RBnidd or the terminal being used by the specified wsn. If the parameter is omitted, all currently connected terminals are disconnected. If the RBnidd form of the parameter is used, the & is required. After the RBX key-in is used, the system will ignore new connections on the affected lines until an RBS key-in is issued.

Table 7. Central Site Messages

Message	Meaning
*BAD WSN ON !RBSW	The wsn specified in an RBSWITCH key-in is invalid. The key-in should be reentered.
*NOTHING VALID FOR RBSW FOUND	There were no files that could be switched as specified in the !RBSWITCH command. Note that a file may only be RBSWITCHed once.
*RBCOM ILLEGAL FOR THIS STATION	The wsn specified on the RBCOM key-in is not that of a master site.
RBnidd - wsn - rbid - status	Response to DISPLAY RBT key-in.
*RBnidd - wsn - (!JOB acct, ...)	The specified job has been accepted from wsn at RBnidd.
*RBnidd CONNECTED	A remote processing terminal has been connected to DSC RBnidd.
*RBnidd - DISCONNECTED	The remote processing terminal that was connected to RBnidd is no longer connected.
*RBnidd ERROR MAX	The remote processing terminal connected to RBnidd is about to be disconnected because of errors detected on the communication line. An RBS key-in will be required to restart the line if DIAL was not specified at SYSGEN.
*RBnidd FAILED TO LOG STATION ON!	An attempt to log on the remote terminal connected to RBnidd was rejected by the monitor.
*RBnidd-wsn*INPUT id,yy[,xxxx]	The system is acknowledging receipt from a remote terminal of an I priority file, i. e., a symbiont input file that does not contain control commands. yy is the input device at the remote site and xxxx is the file name.
*RBnidd INSUFFICIENT STREAMS	An attempt to log a remote terminal onto CP-V is being rejected by the monitor because not enough streams are available for its devices. (Streams are defined with the MXSTRM option on :SDEVICE in SYSGEN.) The workstation will not be able to log on until at least one other line is disconnected.
*RBnidd-wsn-LOGGED ON	Workstation name wsn has been logged on.
*RBnidd-wsn-LOGGED OFF	The wsn has sent an RBDISC command and will be disconnected when output is complete.
*RBnidd-wsn-*MSG*message	A message has been sent from the specified workstation.

5. SYSTEM MANAGER

To establish remote processing as a feature of a CP-V installation, there are two functions that the installation's system manager must perform:

1. Remote processing must be established at SYSGEN.
2. Workstation must be defined using the Super processor.

In addition, this chapter discusses management of the ISCL and RATLER processors.

ESTABLISHING REMOTE PROCESSING AT SYSGEN

SYSGEN is completely described in Chapter 9 of the CP-V/SM Reference Manual, 90 16 74. The four SYSGEN commands that apply to remote processing, :DEVICE, :SDEVICE, :MON, and :FECP, are discussed in the paragraphs below.

:DEVICE COMMAND

All data set controllers (DSCs) to which RBTs and IRBTs may be connected are defined during SYSGEN with :DEVICE commands. Defining a DSC establishes remote processing as a feature of the particular CP-V installation and causes the relevant remote processing handlers and tables to be included as part of the system.

The format of the :DEVICE command is

```
:DEVICE name [, (option)]...
```

where name must be in the format Rbndd and ndd specifies the device address of the DSC being defined. For full-duplex devices, the even address should be specified.

The relevant options are as follows:

$\left\{ \begin{array}{l} 7670 \\ 2780 \\ IRBT \end{array} \right\}$ specifies whether the DSC is usable for Xerox 7670 RBTs, IBM 2780 RBTs, or HASP Multileaving IRBTs. IRBT and 2780 may both be specified for the same DSC, but no other combination is legal. If both 2780 and IRBT are specified for DSCs, either separately for different DSCs or together on the same DSC, either type of terminal can be connected to any DSC for which either 2780 or IRBT (or both) is specified. In this case, for example, an IRBT may be connected to a DSC which was defined for use with 2780s.

$\left\{ \begin{array}{l} FULL \\ HALF \end{array} \right\}$ specifies whether the DSC is full-duplex (FULL) or half-duplex (HALF). The default is HALF.

$\left\{ \begin{array}{l} RBS \\ RBX \end{array} \right\}$ specifies that the line is ready for use at boot-time (RBS) or that the operator must use the RBS key-in to make the line ready for use (RBX). The default is RBS.

WSN,name specifies a one- to eight-alphanumeric character workstation name that is to be automatically associated when the line is connected. This means that the workstation will not need to log on. However, if this option is used, only the specified workstation will be allowed to use the DSC unless the name is changed or removed using the RBLOG operator key-in.

DIAL specifies that this is a dial-up line. If DIAL is not specified, any disconnect of the line (e.g., ERROR MAX) will require an RBS key-in to restart the line.

:SDEVICE COMMAND

In addition to defining data set controllers using the :DEVICE command, the MXSTRM option on the :SDEVICE command must be specified. The :SDEVICE command has the format

```
:SDEVICE [(option)[, (option)]...]
```

MXSTRM is one of several options that may be specified but is the only option that pertains to remote processing. It has the format

```
MXSTRM, value
```

where value specifies, in decimal, the maximum number of symbiont streams that may exist for all concurrently logged on remote workstations. Each device at a workstation accounts for one stream. For example, a Xerox 7670 RBT has three streams — one for the card reader, one for the card punch, and one for the line printer. In effect, the value specifies the maximum number of remote peripheral devices that may exist at concurrently logged on workstations. The maximum value that may be specified is 128. The minimum and default for systems in which remote processing data set controllers are defined is three times the number of DSCs defined. For systems for which DSCs are not defined, the default value is 0.

:MON COMMAND

The :MON command defines various monitor and CPU parameters for the system and has the following format:

```
:MON (option)[, (option)]...
```

Only three of the several options available for :MON are relevant to remote processing. They are

QUEUE,size which specifies, in decimal, the maximum number of I/O operations that may be

queued at one time. The recommended value is a total of one per non-disk type device and two per disk type device. Although a smaller value will work, the minimum should be a total of one per channel and one per disk type device. For standard systems, the value should be 25-30. In addition, the MXSTRM value (see :SDEVICE) should be added to this value for remote processing systems. The default and minimum value for this size is 10.

MPOOL,size which specifies, in decimal, the number of 34-word buffers to be pooled for use by the monitor. It is recommended that the number of MPOOLS be one-half to three-fourths the number of QUEUE entries. For standard systems, the value should be 14-22. One extra MPOOL should be defined for each RB device included in the system. The default value for size is 5.

CPOOL,size which specifies, in decimal, the number of 40-word buffers to be pooled for symbiont context block use. The default is 3. The recommended value is the number of symbiont I/O devices. For remote processing systems, one CPOOL should be added for each RBT line and a number that is approximately three-fourths the maximum number of peripheral devices that could exist at concurrently logged on IRBTs should also be added.

:FECF COMMAND

If data set controllers for RB devices are being simulated by a Front-End Communications Processor, those devices must be defined on the :FECF command. The format of the command is

```
:FECF (FECF, number), (FECF option) _____
_____ [, (FECF option)]... (SRU), (SRU option) _____
_____ , (line specification), (line option) _____
_____ [, (line option)]... [, (line specification)] _____
_____ , (line option)[, (line option)]... _____
_____ [, (SRU)...][, (PROT, 'name'), (char, xx[-yy])] _____
_____ [, (char, xx[-yy])]... _____
```

The command has several options. Those that are particularly relevant to remote processing are described below.

MLINE,id specifies one of the device designations appearing earlier on a :DEVICE command, (e.g., RBA08, RB**1).

PARITY, $\left\{ \begin{array}{l} \text{ODD} \\ \text{EVEN} \\ \text{OFF} \end{array} \right\}$ indicates the parity type being used on the line. The default

is OFF. The following should be used for remote processing devices.

OFF - IRBT, IBM 2780, IBM 3780.

OFF - Xerox 7670 when no parity check is desired.

ON - Xerox 7670 when parity check is desired.

SYNCH specifies that the line is to be synchronous.

BCC, $\left\{ \begin{array}{l} \text{NONE} \\ \text{CRC} \\ \text{LRC} \end{array} \right\}$ specifies what type of validity check to perform on the line. CRC designates character redundancy checking. LRC designates longitudinal redundancy checking. The default is NONE. The following rules apply to remote processing:

1. CRC must be specified for 2780, 3780, and IRBT.

2. LRC may be specified for 7670.

BUF,n specifies the size of the buffer (in bytes) to be associated with the line. The default is 400. The following values should be used:

450 - IRBT and 2780

550 - 3780

150 - 7670

PNAME, $\left\{ \begin{array}{l} \text{BSC} \\ \text{7670} \\ \text{name} \end{array} \right\}$ specifies one of the following:

BSC - the standard protocol for binary synchronous communication (IRBT, IBM 2780, IBM 3780).

7670 - the protocol for the Xerox 7670 RBT.

name - the protocol defined for the name specified on the PROT option of this command.

DEFINING WORKSTATIONS

Workstations are defined using two commands of the Super processor. New workstations are authorized and the authorizations for existing workstations are modified or listed using the WORKSTATION command. Authorizations for existing workstations are deleted using the X command. The Super processor is described completely in the CP-V/SM Reference Manual, 90 16 74. The WORKSTATION and X commands are described below with the description and most of the examples being written for on-line usage. However, Super may also be run in the batch mode.

WORKSTATION COMMAND

The WORKSTATION command is used to authorize a remote workstation, to specify or change options for a particular workstation, and to list options for a particular workstation or for all workstations. The format of the command is

W[ORKSTATION]id

where id is a one- to eight-character workstation name comprised of any of the following characters:

A-Z 0-9 _ \$ * % : # @

If the workstation name is not the name of an authorized workstation, then a new workstation is being authorized.

Options for the WORKSTATION command are entered into the terminal following prompts for options. Options may be specified on the same line separated by semicolons or may appear on separate lines. When no further options are desired, a carriage return alone is entered following a prompt for an option.

The LW option (which causes the options of a workstation or of all workstations to be listed) is a special case. When the LW option is specified, no other options may be specified. In fact, when the LW option is specified, Super outputs the requested listing without prompting for further WORKSTATION options. When the listing is complete, Super prompts for a new command.

General options for the WORKSTATION command are listed in Table 8. The column "Type of Terminal" specifies to which type of terminal (RBT, 2780, or IRBT) the option is applicable. Table 9 lists the device options that are used to define attributes of peripheral devices at IRBTs. These options apply only to the device specified on the DEV option that precedes them. The column "Types" specifies whether the options are legal for input devices (I), output devices (O), or both (I, O).

The industry recognizes several "standard" IRBTs (e.g., COPE 1200 and IBM 360/20 with IRBT software). These standard IRBTs have identical attributes including identical types of peripheral devices. When defining a standard IRBT, the option TYPE = STND may be specified and no further options will be required (in fact, no other options

Table 8. General Options of the WORKSTATION Command

Option	Type of Terminal	Description
LW [=ALL]	RBT, IRBT	Requests that the workstation definition be listed for the workstation specified by id. If =ALL is specified, all workstation definitions will be listed regardless of the id specified for the command. If the LW option is specified, it must be the only option that is specified for the command.
TYPE=type	-	Specifies the type of terminal, where type may be 7670 - Xerox 7670 RBT IRBT - IRBT STND - Standard IRBT (No other options can be specified) 2780 - IBM 2780 RBT The default type is 7670.
$\left\{ \begin{array}{l} \text{SY [STEM]} \\ \text{NS [YSTEM]} \end{array} \right\}$	RBT, IRBT	Specifies whether (SYSTEM) or not (NSYSTEM) jobs in the :SYS account may be submitted from this workstation. The default is NSYSTEM.
RP=n	RBT, IRBT	Specifies the maximum priority for jobs submitted from this workstation, or the maximum priority for files that are being passed directly to an output device. The default value is 7.
GJOB = name	RBT, IRBT	Specifies the 1-7 character name of a ghost job, which will automatically be started when the workstation is connected.
RETRY=n	RBT, IRBT	Specifies, in decimal, the number of times that a failing operation is to be retried before the line is disconnected and the ERROR MAX message is output. Any number in the range 3 to 255 may be specified. The default value is 15.

Table 8. General Options of the WORKSTATION Command (cont.)

Option	Type of Terminal	Description
MLP = n	RBT	Specifies, in decimal, the maximum length of lines printed at the RBT. The defaults are 128 for the 7670 and 120 for the 2780.
MCP = n	RBT	Specifies, in decimal, the maximum number of columns to be punched at the RBT. The default is 80.
LPP = n	RBT	Specifies, in decimal, the number of lines per page at the RBT printer. The default is 39.
{ EM } { NEM }	RBT	Specifies whether (EM) or not (NEM) EM characters may be punched into cards at the RBT. These characters make the decks unusable at central site card readers. If NEM is specified, MCP is ignored. The default is EM.
{ MRB } { NMRB }	2780	Specifies whether this 2780 transmits and receives single record (NMRB) or multi-record (MRB) blocks. The default is NMRB.
{ MS[T] } { SL[V] }	IRBT	Specifies whether the CP-V system will act as the central site (master) or as an IRBT (slave) when this workstation is connected. The default is MST.
DS[M] = mask	IRBT	Specifies, in hexadecimal, a device selector mask used to separate device type from device number. The value specified for mask can range from 0 to FF. The default value is F. (See "Device Selection", below.)
X1	IRBT	Specifies that the IRBT is capable of receiving multiple control records and data records within the same transmission block. (The software of the particular IRBT determines whether this is possible.)
N1	IRBT	Negates an X1 option and is only used when changing the attributes of a workstation. If X1 was never specified for the workstation, N1 is meaningless.
X2	IRBT	Specifies that the workstation is another CP-V system.
N2	IRBT	Negates an X2 option and is only used when changing the attributes of a workstation. If X2 was never specified for the workstation, N2 is meaningless.
X3	IRBT	Specifies that this IRBT is capable of full multileaving. That is, it can accept records for multiple devices within the same block. X3 is the default between X3 and N3.
N3	IRBT	Specifies that this IRBT requires that each block contain records for only one device. A few IRBTs have this restriction.
RM[T] = nn	IRBT	Specifies a two-character remote number. This specification is only valid when CP-V is acting as a slave IRBT to another computer system. The number is assigned by the system manager of the other computer system.
RW[SN] = xxxx	IRBT	Specifies a one- to eight-character WSN to be used by the CP-V system to identify itself when logging onto the remote station being defined. This specification is only valid when CP-V is acting as a slave to another system.
LOGON	IRBT	Specifies that the next line (or card) is the complete log-on record that will be transmitted to the master site when this slave CP-V system logs on. (When Super is called on-line, the record will be automatically blank padded to 80 characters.) LOGON is legal only for workstations for which SLV has been specified. It cannot be used with the RMT or RWSN options.

Table 8. General Options of the WORKSTATION Command (cont.)

Option	Type of Terminal	Description
DEV = devname	IRBT	Specifies the name used on the LDEV command and remote batch control commands to reference a particular device at the workstation. OC is a reserved device name and should be used as the devname if the device is to be used as an operator's console. The OC device cannot be accessed by users. The DEV option is followed by a list of options that define the particular device (see Table 9). Each device of the workstation must be defined in this manner. A minimum of 1 and a maximum of 16 devices may be defined.
DD = devname	IRBT	Specifies that the named device is to be deleted from the workstation definition. Options of a given device cannot be changed individually. The device must be deleted and completely redefined.

Table 9. Device Options of the WORKSTATION Command

Option	Type	Description
{ IN OUT }	-	Specifies whether records for this device are to come IN to or OUT of the CP-V system. Devices capable of input and output must be defined as two separate devices. The default is OUT.
RC[B] = value	I, O	Defines, in hexadecimal, the record control byte used to communicate with the device being defined. The RCB is a one-byte field that specifies the type of device and, in some cases, the number of the device. The required value for the RCB is defined by the software of the IRBT. This option is required because it establishes the connection between the device name specified (DEV = devname) and a particular physical device.
IR[CB] = value	-	Defines, in hexadecimal, the RCB for the operator's console when it is being used as an input device. (The RCB option defines the RCB for the operator's console when it is being used as an output device.) The IRCB option is only valid when an operator's console is being defined.
SU[SBIT] = value	O	Specifies, in hexadecimal, which bit in the Function Control Sequence field is used as the suspend control bit for this device (see Appendix D). The position of the bit that is set to one indicates which bit is the suspend control bit. All other bits are set to zero.
SR[CB] = value	I, O	Specifies the subrecord control byte type for this device. The values may be P – for printer type C – for card type U – for user supplied X – for special printer type If SRCB = U is specified for an output device, the user writing to that device will be expected to supply a subrecord control byte as the first byte of each data record. If it is used for an input device, the subrecord control byte will be passed to the user with each data record. SRCB = C must be specified for input control devices. The default value is C. SRCB = P and SRCB = X represent the two basic types of printer vertical format control. With SRCB = P, most space or skip operations are performed prior to the printing of the line as is common on Xerox printers. With SRCB = X, space or skip operations follow the print. Both types of vertical format control will work correctly for most IRBT printers, but print speed can often be improved by selecting the type which corresponds to the "natural mode" of the printer being used.

Table 9. Device Options of the WORKSTATION Command (cont.)

Option	Type	Description
LI[ST] = x	O	<p>Specifies one of the following:</p> <ul style="list-style-type: none"> Y – this is a listing device. The device will only be used when the user specifically requests it with the LDEV command. N – this is not a listing device. S – this is the system listing device and will be used as the default listing device unless the user specifically requests another listing device. P – this is the system punch device and will be used as the default punch device unless the user specifically requests another punch device. <p>The default is N.</p>
{CT[L]} {NC[TL]}	I	<p>Specifies whether (CTL) or not (NCTL) this device is a control device (i.e., whether or not input from this device is to be scanned for jobs and remote control commands). The default is CTL.</p>
DC = type	I	<p>Specifies the device type of the local symbiont device to which files from this device will be sent directly. The default is NONE.</p>
{SM[D]} {NS[MD]}	O	<p>Specifies whether (SMD) or not (NSMD) this is the system message device (i.e., the device to which messages to the operator will be sent). Only one system message device may be defined for a workstation. The default is NSMD.</p>
{BI[NARY]} {NB[INARY]}	I, O	<p>Establishes whether or not binary input or output is legal for this device. The default is NB.</p>
MA[XREC] = n	I, O	<p>Specifies, in decimal, that the longest record legal for this device may have n bytes. The value n may range from 1 to 255. The default value is 80 unless LIST=Y or LIST=S is specified, in which case the default value is 132.</p>
MI[NREC] = n	I, O	<p>Specifies, in decimal, that the shortest record legal for this device may have n bytes. The value n may range from 1 to 255. The default value is 1. If LIST = Y or LIST = S is specified, then MINREC specifies the maximum number of lines allowed per page. In this case, the value n may range from 1 to 255 and the default value is 38.</p>
PR[IV] = p	I, O	<p>Specifies, in hexadecimal, the privilege level required to use this device. The default value is 40.</p>
KEEP	I, O	<p>Specifies that output files for this device are to be kept intact until the entire file has been output. This allows the complete file to be retransmitted after a line loss. KEEP is only meaningful for input devices if the DC option is also used. In this case, partial input files at a line loss are deleted rather than being output. Input files that are not direct passed are always deleted in this situation.</p>

can be specified). All attributes (including those for peripheral devices) will be automatically established by Super. The devices for standard IRBTs and some of the option values for those devices are listed in Table 10.

The various options are to some degree order-dependent; that is, certain options exclude selection of other options. An incorrect or inappropriate selection of an option will result in a diagnostic response from Super and the option will be ignored. Figure 3 partially clarifies this point. The figure lists all of the options for the WORKSTATION command (with the exception of LW, because it is a special case). The level of indentation indicates the order in which the options should appear; i.e., options that are indented can not be specified unless the option under which they are indented has been previously specified. Within a given level of indentation, the order of appearance of the options is not important. For example, TYPE = IRBT must appear before DSM, but DSM need not appear before X1. The figure does not point out that some options are mutually exclusive (e.g., MST and SLV). However, all cases of mutually exclusive options are obvious from the option descriptions.

DEVICE SELECTION

Users refer to local or remote symbiont devices by name in the DEV option of the LDEV command. If the device is at a remote workstation, then the name of the device was established with the DEV option of the WORKSTATION command. This external name is linked to the actual physical device with the RCB option of the WORKSTATION command. The format and content of the RCB may vary dependent upon the software of the IRBT. Standard RCBs specify a device type and the number of the device. The format of a standard RCB is

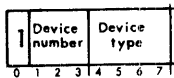

where bit 0 is always set to 1.

For example, if a system using standard RCBs has two line printers, the two RCBs would be

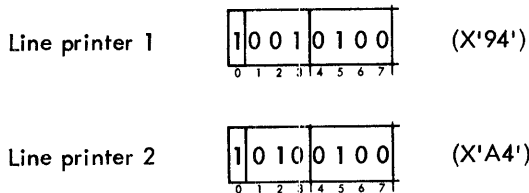

The DSM specifies a device selector mask that determines which bits of the RCB will be used to choose an explicit device. For a standard RCB, a DSM of X'0F' means that only device type will be used in selecting a device and that the number of the device will be ignored.

Table 10. Standard IRBT Device Option Values

Device Type	RCB	IRCB	SRCB	SUSBIT
OC	91	92	C	40
CR	93	-	C	-
LP	94	-	P	800
CP	95	-	C	1

```

WORKSTATION id
  SYS
  NSYS
  RP
  GJOB
  RETRY
  TYPE=STND
  TYPE=7670
    EM
    NEM
    MCP
    MLP
    LPP
  TYPE=2780
    EM
    NEM
    MCP
    MLP
    LPP
    MRB
    NMRB
  TYPE=IRBT
    DSM
    X1
    N1
    X2
    N2
    X3
    N3
    DD
    MST
    SLV
    RMT
    RWSN
    LOGON
  DEV=OC
    IRCB
  DEV=any device (including OC)
    PRIV
    RCB
    SRCB
    MAX
    MIN
    DIR
    NDIR
    BIN
    NBIN
    IN
    CTL
    NCTL
    DC
    OUT
    SUSBIT
    LIST
    SMD
    NSMD
  KEEP
  
```

Figure 3. WORKSTATION Command Options

For example, assume that the following DSM and line printers have been defined:

```
DSM=0F
DEV=LP      (line printer 1)
RCB=94
DEV=PR      (line printer 2)
RCB=A4
```

If the user requests the device LP, he will get either LP or PR (line printer 1 or line printer 2) — whichever device is available. The request for LP is translated to RCB=94, but the DSM specifies that only the low-order four bits (type) are to be used. Therefore, no distinction is made between device number one and device number two.

A DSM of FF means that the entire RCB is to be used in selecting the device. In the example above, a DSM of FF would mean that the user would get the device LP when he specified LP and PR when he specified PR.

A DSM of 00 means that the RCB is to be ignored completely in selecting a device, regardless of the device name specified by the user.

Note that the setting of the first bit in the DSM is not important because the first bit of the RCB is always set to 1 (even if the RCB is not a standard RCB) and the first bit of the DSM is effectively ignored. Therefore the following DSMs are equivalent:

```
00 and 80
0F and 8F
7F and FF
```

Note also that the bit settings of the DSM have a different meaning for RCBs that have a format other than the standard format. Generally speaking, however, the role of the DSM is the same for all RCB formats. It specifies which bits of the RCB will be used to select a device.

GENERAL EXAMPLES

1. Assume that workstation STA1 with three devices (an operator's console, a card reader, and a line printer) is to be defined.

```
--WORKSTATION STA1 (RET)  Workstation name is STA1.
--TYPE=IRBT (RET)        Type of remote terminal is IRBT.
--DEV=OC (RET)           The first device defined is the OC.
--RCB=91 (RET)          Standard operator's console RCB.
--IRCB=92 (RET)         Standard operator's console IRCB.
--SMD (RET)             This is the system message device.
--SUSBIT=40 (RET)       Suspend control bit is bit 9.
--DEV=CR (RET)          The second device defined is called CR.
--IN (RET)              CP-V will receive records from this device.
--RCB=93 (RET)          Standard card reader RCB.
--DEV=LP (RET)          The third device defined is called LP.
--RCB=94 (RET)          Standard line printer RCB.
--SUSBIT=800 (RET)      Suspend control bit is bit 4.
--SRCB=P (RET)          Standard printer SRCB.
--LIST=S (RET)          This is the system listing device.
-- (RET)
```

2. Assume that a standard workstation with the workstation name STANDARD is to be defined and that the attributes of the workstation are then to be listed.

```
--W STANDARD (RET)
--TYPE=STND (RET)

--W STANDARD (RET)
--LW (RET)
```

```
ID= 4 STANDARD
TYP=IRBT
MODE=MST
DSM= 0F
RP= 07
IRCB= 92
SMD= 0C
RETRY=15
DEVICES 4
```

DEV	RCB	SRCB	SUS	I/O	LIST	CTL	BIN	KP	PRV	DC	MAX	MIN
OC	91	C	0040	OUT	N	N	N	N	40	00	80	1
CR	93	C	0000	IN	N	Y	N	N	40	00	80	1
LP	94	P	0800	OUT	S	N	N	N	40	00	132	38
CP	95	C	0001	OUT	P	N	N	N	40	00	80	1

3. Assume that workstation PLANT2 is to be defined. PLANT2 is a standard workstation with the exception that it does not have a card punch.

```
--W PLANT2 (RET)
--TYPE=STND (RET)
--W PLANT2 (RET)
--DD=CP (RET)
-- (RET)
```

Note that when TYPE=STND is entered, Super prompts for a new command rather than allowing further options for the WORKSTATION command.

Punched output from a job submitted from a remote terminal that does not have a punch is punched locally unless the punch output is directed elsewhere by either the JOB or LDEV command.

4. Assume that a standard workstation with the workstation name STA2 is to be defined, but due to the installation's paper stock, the maximum number of lines allowed per page on the LP device can only be 25 rather than 38.

```
--W STA2 (RET)
--TYPE=STND (RET)
--W STA2 (RET)
--DD=LP (RET)
--DEV=LP (RET)
--RCB=94 (RET)
--SUSBIT=800 (RET)
--SRCB=P (RET)
--LIST=S (RET)
--MINREC=25 (RET)
-- (RET)
```

5. Assume that workstation BLDNG5 is to be defined. BLDNG5 is a standard workstation with the exception that it does not have an operator's console. The line printer is to be defined as the system message device.

```

-W BLDNG5 (REF)
--TYPE=STND (REF)
-W BLDNG5 (REF)
--DD=OC (REF)
--DD=LP (REF)
--DEV=LP (REF)
--RCB=94 (REF)
--SUSBIT=800 (REF)
--SRCB=P (REF)
--LIST=S (REF)
--SMD (REF)
-- (REF)

```

System messages will be sent to the line printer in message files between normal print output files.

6. Assume that workstation BOSTON is to be defined. BOSTON is a standard workstation with the exception that it has an additional device—a tape drive with the following characteristics:
- The RCB for input is 99.
 - The RCB for output is 98.
 - The SUSBIT is 20.
 - The SRCBs contain tape positioning information.
 - The maximum legal record size is 100 bytes and the minimum is 10.
 - Input from the device is not to be scanned for control commands.
 - Only users with privilege B0 or greater may access this device.

The definition of this workstation would be

```

-W BOSTON (REF)
--TYPE=STND (REF)
-W BOSTON (REF)
--DEV=TI (REF) (tape in)
--RCB=99 (REF)
--IN (REF)
--NCTL (REF)
--SRCB=U (REF)
--PRIV=B0 (REF)
--MAX=100 (REF)
--MIN=10 (REF)
--BIN (REF)
--DEV=TO (REF) (tape out)
--RCB=98 (REF)
--SUSBIT=20 (REF)
--SRCB=U (REF)
--PRIV=B0 (REF)
--MAX=100 (REF)
--MIN=10 (REF)
--BIN (REF)
-- (REF)

```

Programs that contain routines to supply and use the tape positioning SRCBs can now access input files from the tape with a command such as

```
ILDEV R1, (WSN, BOSTON), (DEV, TI), (SRCB)
```

and write output files to the tape through use of a command such as

```
ILDEV R1, (WSN, BOSTON), (DEV, TO), (SRCB)
```

DEFINING A MASTER COMPUTER SYSTEM AS A WORKSTATION IN A SLAVE CP-V

The CP-V remote processing system supports a CP-V multi-leaving system acting as a standard IRBT (such as a COPE 1200) to another computer system acting as the master. (Other configurations for the CP-V IRBT are possible but modifications to the master system might be required.)

When CP-V and a master system are communicating, each system must have defined the other system as a workstation. A sample Super run (in the batch mode) for defining the master as a workstation in CP-V is listed in Figure 4.

Note that no system message device is defined since the master system does not expect system messages from the IRBT.

If such a workstation is defined in the CP-V system, a user can then submit a job to the other system by a command such as

```
ILDEV R1, (WSN, STA10), (DEV, JE)
```

followed by commands that copy the job to R1. Any print and punch output of the job returned by the master system is automatically printed and punched on the local printer and punch with a banner indicating its origin.

With the workstation definition in Figure 4, the master system's remote control commands may be entered by the CP-V operator via the RBCOM key-in. For example,

```
IRBCOM STA10 $IDJ 15
```

System messages from the master will appear on the CP-V OC as

```
*RBnnd - STA10 *MSG* message from master system
```

DEFINING WORKSTATIONS FOR CP-V TO CP-V COMMUNICATION

When two CP-V systems are connected via remote processing, workstations can be defined for a wide variety of applications, ranging from one CP-V system acting simply as a remote terminal to a varied combination of job sharing, special device usage, and file passing between two systems.

W STA10	
TYPE=IRBT	
SLV	CP-V is the slave system.
RMT=05	Remote number assigned by the system manager of the master system.
RWSN=CPV007	Password assigned by the system manager of the master system.
DEV=0C	CP-V operator's console.
RCB=92	Note that the RCBs are reversed; they appear to be normal to the master system.
IRCB=91	
SUSBIT=40	
DEV=JE	Job entry.
RCB=93	Corresponds to master system's card reader.
SUSBIT=1	Master system's card reader susbit.
MAX=80	EBCDIC card images only.
MIN=80	
PRIV=A0	Job entry is to be limited to users with A0 privilege or greater.
KEEP	Resubmit whole job if line is lost.
DEV=LI	Listing in.
RCB=94	Corresponds to master system's line printer.
IN	
SRCB=P	
NCTL	
MAX=132	
DC=LP	Print input files are passed directly to the local printer.
DEV=PI	Punch in.
RCB=95	Matches master system's card punch.
IN	
NCTL	
DC=CP	Punch input files are passed directly to the local punch.

Figure 4. Sample Definition of a Master System as a Workstation in CP-V

In any case, each CP-V system must have defined the other CP-V system as a workstation. The samples in Figures 5 and 6 show the definition of two CP-V workstations, CPVA and CPVB, with Super being run in the batch mode. For sake of clarity, the two CP-V systems are referred to as Computer A and Computer B. Workstation CPVB is defined in Computer A and workstation CPVA is defined in Computer B. Figure 7 depicts the communication paths that are available as the result of these workstation definitions.

When CPVA and CPVB are connected, the following are permitted:

1. A user at either machine can submit a job to the other machine and receive the print and punch output at his own machine.
2. CPVA users can use the plotter at Computer B. (Their machine does not have a plotter.)
3. User programs in either machine can pass files of unstructured data to user programs in the other machine.
4. The operator of either system can use the RBCOM key-in to enter remote batch control commands to the other system.
5. System messages from CPVB appear on CPVA's printer and vice versa.

Note the following in the two workstation definitions:

1. X1 and X2 are used in both definitions. X1 increases processing speed, and X2 provides features such as RBCOM key-ins valid from master to slave, and form names automatically transferred between systems.
2. No SUSBITs are used. CP-V systems never suspend individual streams coming into them because all inputs are buffered on disk.
3. Each input device in CPVA has an output device in CPVB with the same RCB and vice versa. (Some of the devices are actual physical devices and others are pseudo devices.) Each of these pairs of devices constitutes a communication path between the machines. (A device in one machine for which there is no device with a matching RCB in the other machine cannot be used to communicate with the other machine.)
4. The sets of RCBs are chosen at random. They have no meaning except to connect devices in the two machines.
5. It makes no difference which machine is master and which is slave, although there must be one of each.
6. No privilege levels are specified. This is merely for brevity. Any or all of the devices could have special privilege levels defined for them.

W CPVB	
TYPE=IRBT	
SLV	Computer A is the slave.
X1	
X2	
RWSN=CPVA	Computer A's workstation name in CPVB.
DEV=OC	Operator's console.
RCB=91	
IRCB=92	
SMD	
DEV=JE	Jobs submitted to computer B.
RCB=93	
BIN	
MAX=120	
MIN=80	
KEEP	
DEV=LI	
RCB=94	
IN	
NCTL	
MAX=132	
SRCB=P	
DC=LP	
KEEP	
DEV=PI	Punch in from CPVB.
RCB=95	
IN	
NCTL	
MAX=120	
BIN	
DC=CP	
KEEP	
DEV=CR	Card reader from CPVB.
RCB=96	
IN	
BIN	
MAX=120	
MIN=80	
DEV=LP	Line printer at CPVB.
RCB=97	
SRCB=P	
LIST=S	
KEEP	
DEV=CP	Card punch at CPVB.
RCB=98	
LIST=P	
BIN	
MAX=120	
KEEP	
DEV=PL	Plotter at CPVB
RCB=99	
MAX=140	
BIN	
KEEP	
DEV=FI	Files in from CPVB.
RCB=9A	
IN	
NCTL	

Figure 5. Definition of Workstation CPVA in Computer A

BIN	
MAX=140	
DEV=F0	Files out to CPVB.
RCB=9B	
BIN	
MAX=140	
KEEP	

Figure 5. Definition of Workstation CPVA in Computer A (cont.)

W CPVA	
TYPE=IRBT	
MST	Computer B is the master.
X1	
X2	
DEV=OC	Operator's console.
RCB=92	
IRCB=91	
SMD	
DEV=CR	Card reader from CPVA.
RCB=93	
IN	
BIN	
MAX=120	
MIN=80	
DEV=LP	Line printer at CPVA.
RCB=94	
SRCB=P	
LIST=S	
KEEP	
DEV=CP	Card punch at CPVA.
RCB=95	
LIST=P	
BIN	
MAX=120	
KEEP	
DEV=JE	Jobs submitted to CPVA.
RCB=96	
BIN	
MAX=120	
MIN=80	
KEEP	
DEV=LI	Listings in from CPVA.
RCB=97	
IN	
NCTL	
MAX=132	
SRCB=P	
DC=LP	
KEEP	
DEV=PI	Punch in from CPVA.
RCB=98	
IN	

Figure 6. Definition of Workstation CPVA in Computer B

```

NCTL
MAX=120
BIN
DC=CP
KEEP
DEV=PX
RCB=99
IN
NCTL
BIN
MAX=140
DC=PL
KEEP
DEV=FO
RCB=9A
BIN
MAX=140
KEEP
DEV=FI
RCB=9B
IN
NCTL
BIN
MAX=140

```

Plotter input from CPVA.

Files out to CPVA.

Files in from CPVA.

Figure 6. Definition of Workstation CPVA in Computer B (cont.)

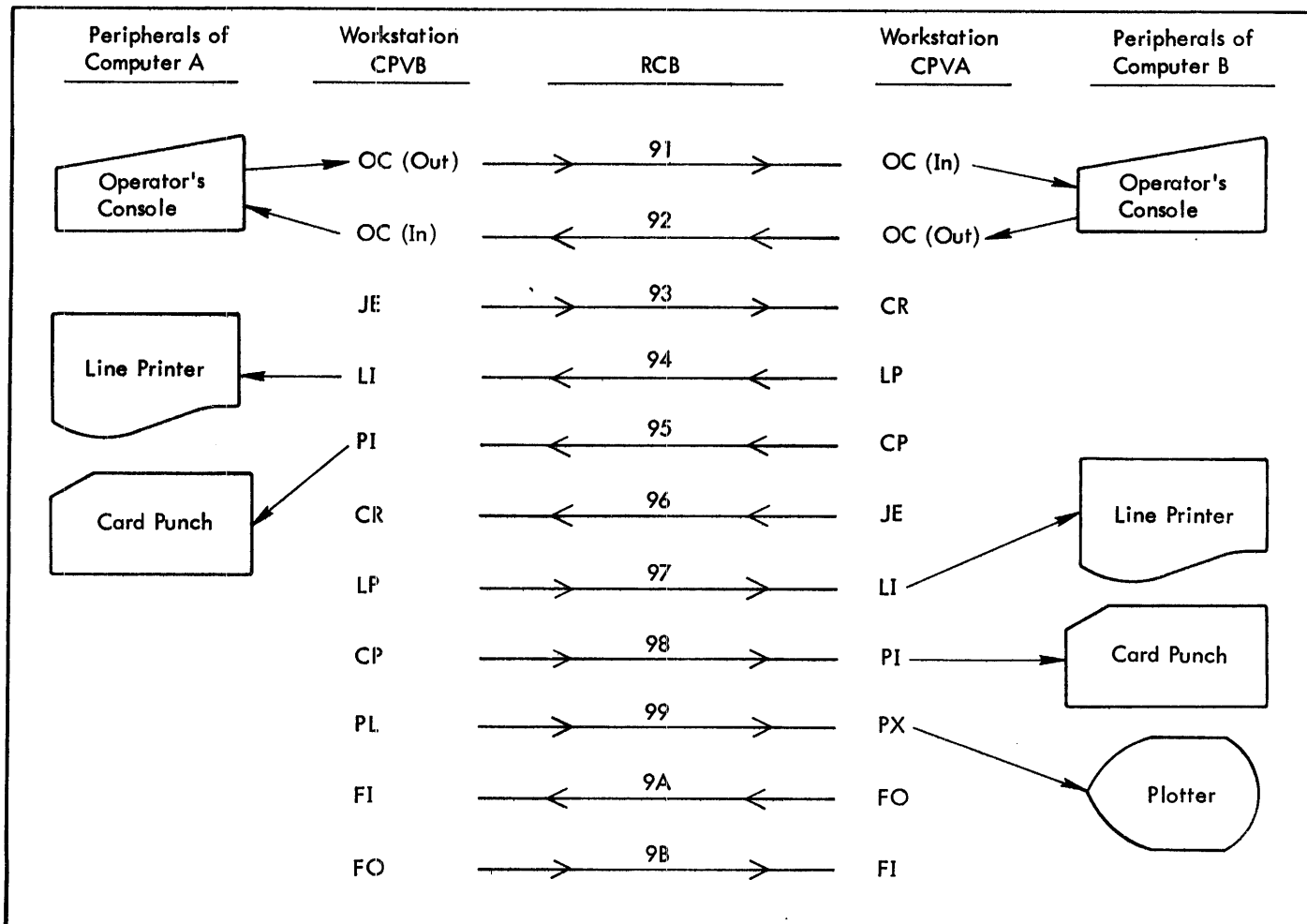

Figure 7. Communication Paths between CPVA and CPVB

7. No device has a MAX option greater than 140 bytes. This (140 bytes) is the maximum record length allowed for records input to the CP-V system (a symbiont restriction).
8. The KEEP option is used to simplify restart after a line loss.

X COMMAND

A workstation authorization may be deleted with the X command. The format of the command is

X id

where id specifies the workstation name of the workstation definition to be deleted.

Example:

```
_X STA1 (E)
```

ISCL/RATLER MANAGEMENT

To successfully use the ISCL/RATLER facility, the workstations involved must be defined appropriately. Figure 8 is a typical workstation definition for a workstation which will make use of ISCL and RATLER. Specifying GJOB=RATLER guarantees that RATLER, a required ghost processor of this facility, will be executing when the workstation is available. (The operator may also initiate RATLER whether or not this workstation logs on.)

The device FI (files in) and FO (files out) are designed for exclusive use of ISCL and RATLER. For reasons of file security, they should have a privilege level of CO required for access. The KEEP option is specified to ensure that the file will be transmitted. If it is not specified, line disconnects and recoveries can cause files and requests to be lost.

Control of the RATLER processing is maintained through the file RATL in the :SYS account. RATL is an Edit file with one name per record. This file should specify those workstation names for which processing is desired immediately. RATLER will not process any input from workstations other than those listed in the RATL file. Since significant overhead is associated with each name, dynamic maintenance of the file is the optimal means of controlling the facility.

ISCL STANDING ORDERS

Periodic requests can be carried out automatically through the use of "standing orders" in the file ISCLS in the :SYS account. Each record in the file is a command for the ISCL processor, with an Edit key indicating the time the command is to be issued. The keys are of the form

abbb.ccc

where the digit a indicates the day of the week (1 for Sunday, 2 for Monday, etc.), bbb are the first three digits of the time of day on a 24-hour clock, and ccc is a relative sequence number which allows multiple orders at a particular time. The first record of a set of orders must be of the form

FOR account

where account is the account of the user for whom the service is being performed. (If a FOR record does not exist for a set of commands, the most recent account specified in a FOR record is used.) The rest of the records in the set are ISCL commands.

To enable these "standing orders" to be processed, the RATLER ghost must be running.

WORKSTATION CPVB	
TYPE=IRBT	
SLV	Computer A is the slave.
X1	
X2	
GJOB=RATLER	
.	
.	
.	
DEV=FI	Files in.
RCB=9A	RCB choice is arbitrary as long as definitions are consistent.
IN	
NCTL	
BIN	
MAX=132	
PRIV=CO	
KEEP	
DEV=FO	Files out.
RCB=9B	
BIN	
MAX=132	
PRIV=CO	
KEEP	

Figure 8. Definition of an ISCL/RATLER Workstation

APPENDIX A. CONNECTING REMOTE SITE AND CENTRAL SITE TELEPHONE LINES

There are several types of data sets that may be used to connect a remote site to the CP-V system via telephone lines. The most frequently selected type is the Bell System 201A or 201B data set. This data set can be used in full-duplex configuration or in half-duplex configuration. Operating procedures for the two configurations are discussed separately.

FULL-DUPLEX CONFIGURATION

The Bell System 201A or 201B data set used with the remote processing system in full-duplex configuration does not have an automatic answering capability. Therefore, the central site operator must work with the remote site operator to establish a manual connection of the data set lines.

Most full-duplex data sets have the following six buttons:

AUX DD1 DD2 TEST TALK DATA
(HOLD) (XMIT) (REC'V)

The buttons perform the following functions:

AUX	Used to put a data line in auxiliary mode so that the phone may be used to dial the other data line.
DD1,DD2	Used to connect the phone to the line for dialing, answering, and vocal communication.
TEST	Used for line testing by the phone company. (It is not used in data transmission or in the data line connection procedure.)
TALK	Used to change the data set from the data communication mode to the voice communication mode.
DATA	Used to change the data set from the voice communication mode to the data communication mode.

A data set should always be maintained in the voice communication mode when it is not connected to another data set for data communication purposes. In this mode, it is like any standard telephone with two phone lines and two phone numbers associated. When in this mode, the data set will have none of the lights in the buttons illuminated, and only the TALK button will be depressed.

The sequence for connecting the central site data set and the remote site data set must be followed carefully. In most cases, the remote operator initiates the connection sequence. Therefore, the operation will be described with the remote operator initiating the sequence. The central site operator may initiate the sequence, however. In this case, the functions of the two operators are reversed.

The remote operator picks up his handset (with TALK depressed) and depresses the DD1 button to get a dial-tone. He dials the number of the central site data set's DD2 line. The central site operator answers the phone by picking up the handset (again with TALK depressed) and depressing his blinking DD2 button. The ringing is stopped and vocal connection is automatically made. Each operator then depresses his AUX button. The remote site DD1 is now connected to the central site DD2 and the connection sequence is halfway completed. Neither operator may hang up at this time because to do so would disconnect the phones and the sequence must be restarted. The remote operator now depresses his DD2 button to get the dial tone and he dials the central site DD1 number. The central site operator answers the phone by depressing his blinking DD1 button. Each operator now depresses the AUX button once again. The final connection is made when each operator depresses the DATA button. Each phone should now have no buttons depressed and the DD1, DD2, and DATA lights on, whereupon each operator may hang up the handset and proceed with other work. If at any time any of the three lights, DD1, DD2, or DATA, are not illuminated and the handset is hung up, the connection must be considered broken and a complete dialing sequence is necessary.

The button and dialing sequences for connecting a remote site to the system are summarized in Figure A-1.

<u>LOCAL</u>	<u>REMOTE</u>
	Dial DD2 on DD1
Answer DDA AUX	AUX Dial DD1 on DD2
Answer DD1 AUX DATA Hang up	AUX DATA Hang up

Figure A-1. Connecting a Remote Site to the System

HALF-DUPLEX CONFIGURATION

In the half-duplex configuration, the data set can automatically answer. Most half-duplex data sets have the following buttons:

AUTO ____ ____ TEST TALK DATA .

The central site data set should be maintained with the TALK button not depressed (obtained by depressing the

DATA button), the AUTO button depressed, and the handset hung up. To establish connection, the remote operator may then pick up his handset, depress TALK to get the dial tone, dial the central site data set, depress DATA when the automatic answer occurs, and hang up to complete the connection. The central site operator may establish the connection, in which case the remote site data set should be maintained as described above for the central site data set and the central site operator follows the same steps outlined for the remote site operator.

APPENDIX B. OPERATION OF IRBTs AND 2780s

Due to the variety of IRBTs that may be used with CP-V remote processing, it is not within the scope of this manual to describe the operational features of each type of IRBT. Therefore, each IRBT operator should familiarize himself with the operator's manual that is supplied by the manufacturer of his particular type of terminal. However, there are several operational considerations that are common to all IRBTs and that are largely a function of the design of the CP-V remote processing system. These are discussed in the paragraphs that follow.

PREPARING FOR CONNECTION TO CP-V

The following steps should be taken before an IRBT or 2780 is connected to a CP-V system:

1. Prepare an appropriate log-on command.

Most IRBTs allow the log-on command to be the last card of the deck that is used to boot the IRBT. The log-on command is usually referred to as the /*SIGNON command. However, many IRBTs and all 2780s accept this card without checking its syntax. In such case, the /*SIGNON command should be replaced with the RBID command

```
!RBID wsn [message]
```

Other IRBTs require the /*SIGNON command but allow the command syntax to be the same as that for the RBID command

```
/*SIGNON wsn [message]
```

Certain IRBTs check to ensure that the strict syntax of the /*SIGNON command is used as the log-on command. The /*SIGNON command has the following format:

```
/*SIGNON REMOTEnn [password]
```

where nn is any one- or two-digit decimal number. In this case, the workstation name of the IRBT must be REMOTEnn and the password, if present, is treated by CP-V as a message. This is a rare case and may be avoided by use of the RBLOG key-in.

2. Boot the IRBT according to the directions in its particular operations manual. Make certain that the following are true:
 - a. The buffer size is 400 characters for multirecord block terminals.
 - b. The terminal is in the transparent mode for IRBTs, nontransparent for 2780 RBTs.
 - c. All necessary peripheral devices are powered on.

3. Initiate the control program in the IRBT. (It is good practice to have the IRBT sending its ENQ character before the phone line is connected.)
4. Follow the dial-up procedure outlined in Appendix A.

LOGGING ONTO CP-V

When an IRBT or 2780 is connected to the CP-V system, a log-on command must be sent unless one of the following is true:

1. The central site operator has performed an RBLOG key-in.
2. An automatic log-on workstation name was defined for the particular line at SYSGEN.

When a log-on command is sent, confirmation should be received within 20 seconds on the system message device. The confirmation has the following format:

```
*****wsn LOGGED ONTO DSC * RBnnd AS RBID n
```

where

wsn is the workstation name.

RBnnd specifies the data set controller to which the phone line has been connected.

n is the remote batch identifier (RBID) assigned to the line.

If a log-on command is sent even though either the central site operator has performed an RBLOG key-in or an automatic log-on workstation name was defined for the particular line at SYSGEN, the log-on command will be ignored by CP-V. In this case, it is possible that the wsn in the confirmation message will differ from the wsn specified in the log-on command.

If a log-on command is sent and no confirmation is received, one of the following has occurred:

1. The telephone connection is faulty or incomplete.
2. The central site is not currently operating.
3. The workstation name on the log-on command is either invalid or already in use.

If no confirmation is received, call the CP-V operator to determine the reason for the problem.

FIN COMMAND

The FIN command should never be used to terminate a job stream from an IRBT or 2780. All of these terminals have either a switch or a command to their own programs that indicates end-of-file or send an end-of-file automatically upon notification from the input device that the input stream has been completely read. If a FIN command is included in the input, the message

*CARDS FOLLOWING FIN/RBID IGNORED

will be printed on the system message device and the FIN command and any input between it and end-of-file is discarded.

INTERRUPTIONS IN PHONE CONNECTION

If the phone connection between the remote and central sites is broken and the disconnect was not initiated by the remote operator, the disconnect is probably due to one of the following reasons:

1. A telephone equipment failure.
2. Excessive line errors. (The CP-V system disconnects a line if excessive errors occur on it.)

3. The central site is recovering from a crash. In this case the following message is sent to the terminal.

RECOVERY SAYS RE-DIAL

When any line disconnect occurs, it is necessary to reinitialize the terminal, reconnect the line, and log onto the CP-V system again. Any output being produced at the time of an interruption is saved at the symbiont retry point and will be available whenever the workstation logs on again. Files that are being input when the interruption occurs are discarded.

DEVICE CONTROL COMMANDS

Some device control commands such as RBSUSPEND and RBABORT may seem to require a long time to take effect when entered from an IRBT. This is due to the fact that some of the output for the device is already buffered in the IRBT itself and the command cannot take effect until this data and any on the line at the time of the command has been output to the device by the IRBT. This delay is less pronounced with higher speed output devices.

APPENDIX C. OPERATION OF THE XEROX 7670 REMOTE BATCH TERMINAL

Personnel involved in operating a Xerox 7670 Remote Batch Terminal should familiarize themselves with the Xerox Remote Batch Terminal/Operator's Manual, 90 16 26, and the Xerox Remote Batch Terminal/Reference Manual, 90 16 02. These documents provide detailed descriptions of operating procedures for the Xerox 7670.

Operating procedures are briefly described below. Figures C-1, C-2, and C-3 provide pictures of an RBT and its control panels.

PREPARING AN RBT FOR CONNECTION TO THE SYSTEM

Before a 7670 is connected to the CP-V operating system, it must be made ready in the following manner:

Maintenance Panel Switches

SHORT BLOCK – ON
PARITY CHECK – users option
TEST MODE – OFF

Read/Punch Switches

READ/PUNCH – READ

Transmit Control Switches

BLOCK LENGTH – 80
SELECT TRANSMIT UNIT – READER
SELECT REMOTE RECEIVE UNIT – OFF

Receive Control Switches

BLOCK LENGTH – 128
SELECT RECEIVE UNIT – REMOTE

System Control Switches

POWER – ON
RUN/STOP – RUN
MODE – ON-LINE
– ATTENDED OR UNATT'D

When all switches are appropriately set, GENERAL CLEAR in the System Control area should be operated. The 7670 is now ready to be connected to the system.

The 7670 RBT may be operated in either ATTENDED or UNATT'D mode and this mode may be changed during operation. In general, ATTENDED mode should be used when an RBT operator is present and UNATT'D when the RBT is unattended. The major differences in these modes are described where applicable in the following sections.

LOGGING ON

When a 7670 RBT is connected to a CP-V operating system the system responds with the salutation on the printer of the RBT. The user places an IRBID card (and only this card) in the hopper and presses CARD FEED followed by TRANSMIT. The card is read by the system which checks the authorization of the user and, if it is correct, logs him on. If the IRBID command was illegal, the user is told why, the salutation is repeated, and the user must try to log on again.

When the user is successfully logged on to CP-V, he receives his first message file informing him that he is logged on and giving the status of any files he has in the system. The log-on process is now complete.

ENTERING JOB STREAMS

When the remote user wishes to transmit jobs to the CP-V system, he places a job stream in the hopper of the 7670 and follows the appropriate procedure below.

1. Unattended Mode
 - a. Press CARD FEED.
 - b. Press TRANSMIT.

If output is in progress, the job stream is transmitted when output is completed.

2. Attended Mode
 - a. Wait until the RECEIVE light is out.
 - b. Press CARD FEED.
 - c. Press TRANSMIT.

Job streams can only be sent when output is in progress by suspending current output using the procedures in the section below titled "Suspending an Output Symbiont". When the hopper goes empty, press SEND EOT several times.

If a job stream is too large for the 7670 input hopper, it may be sent in several shorter segments. This is done simply by placing a part of the stream in the hopper without a

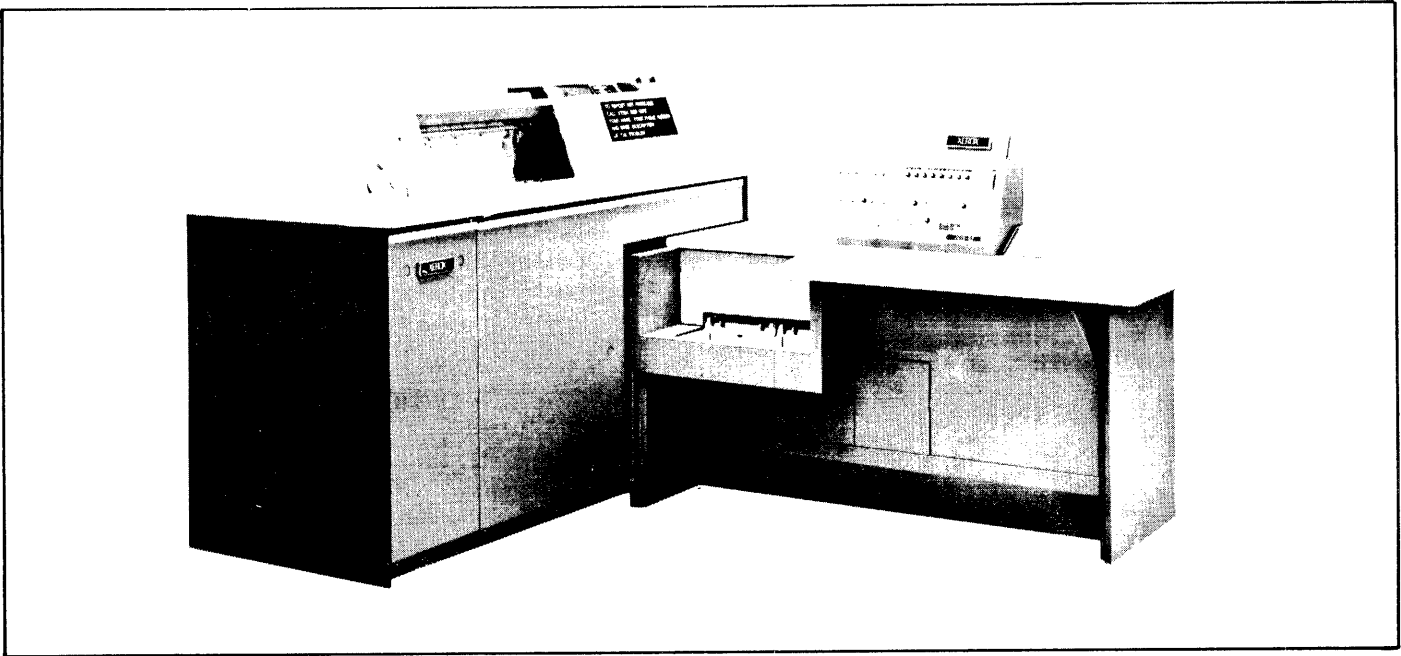

Figure C-1. Xerox 7670 Remote Batch Terminal

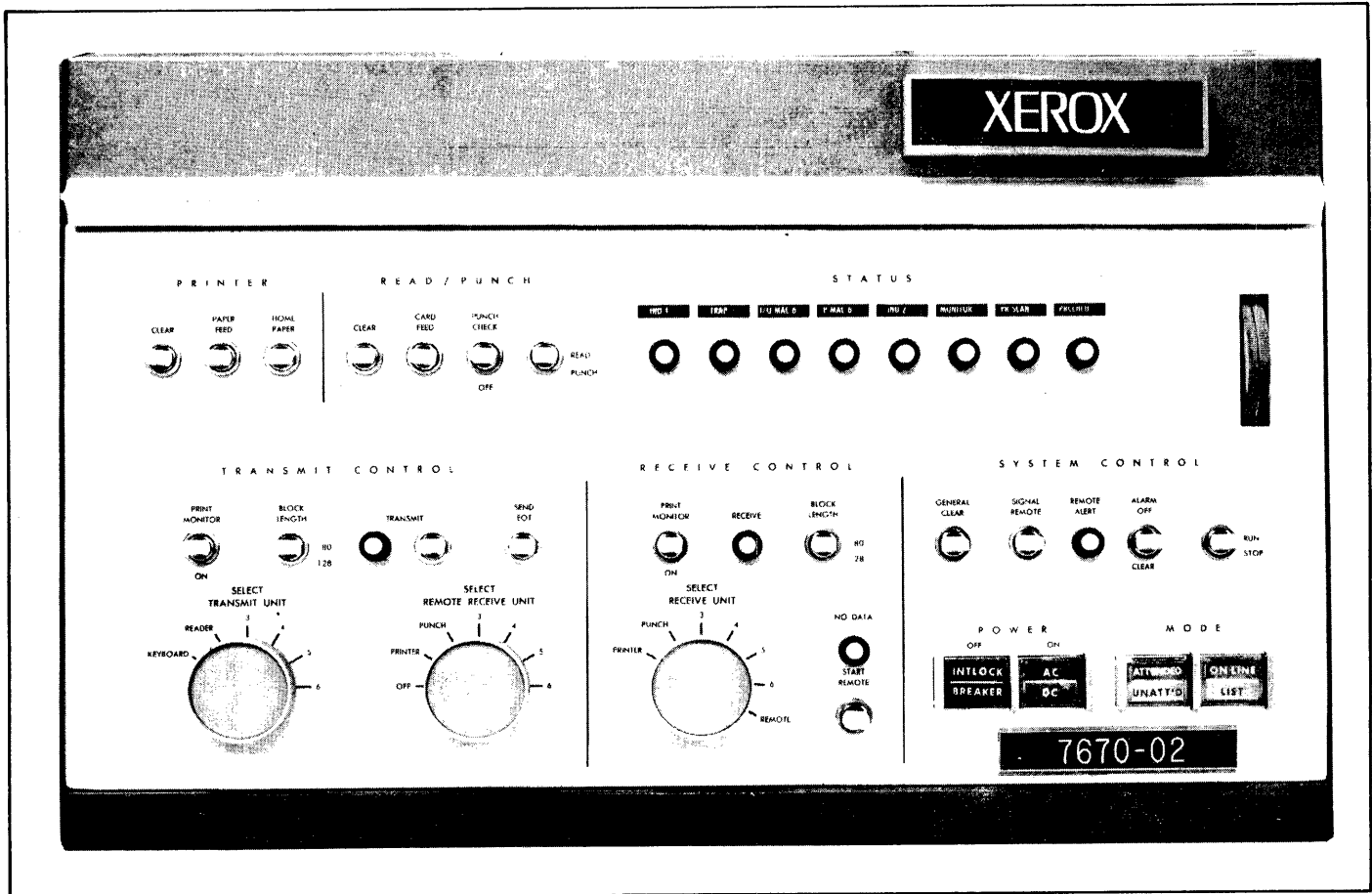

Figure C-2. Xerox 7670 RBT Control Panel

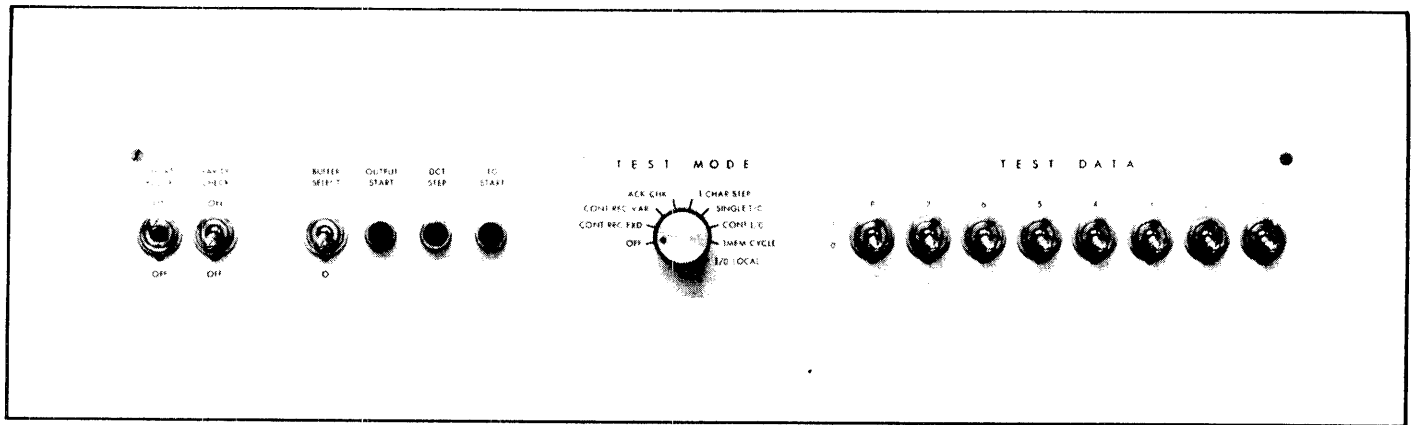

Figure C-3. Xerox 7670 RBT Maintenance Panel

!FIN and transmitting it normally, then transmitting the next part, and so on. Once input has begun, the system will continue to read cards until a !FIN has been received and will not transmit output until this has occurred.

RECEIVING PUNCHED OUTPUT

Since the same hopper is used for both reading and punching on the 7670, punched output is not transmitted as soon as it is ready. Instead, the user is informed in his message file when punched output is available. When he wishes to receive the output, he must take the following steps in order:

1. Set READ/PUNCH to PUNCH.
2. Place blank cards in the hopper.
3. Press CARD FEED.
4. Set RUN/STOP to STOP.
5. Press SIGNAL REMOTE several times.
6. Reset RUN/STOP to RUN.

All available punched output will now be sent.

If printed output is in progress when STOP is pressed, the remote signal may be sent. For this reason, it is recommended that this operation be performed in ATTENDED mode. The print file will be completed before the punch is sent.

It is possible to direct punched output to the printer by setting SELECT RECEIVE UNIT to PRINTER and following steps 4 through 6 above.

SUSPENDING AN OUTPUT SYMBIONT

If a user wishes to send a job stream to CP-V while output is in progress, he can do so in the following manner.

1. Press GENERAL CLEAR.
2. Press SEND EOT several times.

This operation must be performed in ATTENDED mode. CP-V will complete any format operation in progress, suspend the output symbiont, and wait to read a job stream. When the job stream has been received, the output will be restarted at the symbiont retry point unless the job stream contained an RBCONTINUE, RBREPRINT, RBABORT, or RBSAVE command.

LOGGING OFF

A user can log his 7670 RBT off of the system by including an RBDISC control command in a job stream. Processing of the job stream is completed and confirmation of the log-off is placed in the message file, which is output followed by any printed and punched (if requested) output available for the work station. When this is completed, the RBT is disconnected from the operating system.

DISCONNECTING AN RBT FROM THE SYSTEM

If output is being sent to a 7670 when it disconnects (either deliberately or due to a transmission line fault) from the system, the file is saved at the symbiont retry point and will be available when the work station has logged on again. This is also true of files that are suspended unless an IRBABORT has been received. Message files are not saved in this manner.

If input is being read from a 7670 RBT when it disconnects, the partially input job must be reentered together with any IRB commands that may immediately precede it. All other jobs are received correctly and will be executed.

HANDLING ERRORS

Error conditions may occur in remote operations because of faults in local or remote hardware, or transmission line difficulties. All of these errors are logged by the remote processing system in the system error log. When the 7670 RBT detects errors itself, it sounds its alarm after

appropriate retries. When the CP-V remote processing system is unable to read a record correctly from a 7670 or does not receive a positive acknowledgment for a record it has sent to the 7670, it sounds the alarm on the 7670. The effect at the 7670 is thus the same for 7670 and system detected errors.

When the alarm on the 7670 sounds and it is in UNATT'D mode, it automatically disconnects itself from its communication lines, saving the user from wasting expensive line time with a faulty 7670 RBT. The following discussion of handling errors deals with ATTENDED mode only.

When the alarm sounds at the 7670, the action to be taken is the same regardless of whether input or output is in progress. The alarm is also sounded when the system disconnects the 7670 RBT because of a user log-off or a central site operator key-in that disconnects the user. The 7670 operator should first check that this has not occurred. The appropriate BLOCK LENGTH switch and the STOP switch should be checked, and, if in error, corrected. If neither of the above is the cause of the alarm

1. Press GENERAL CLEAR.
2. Press SEND EOT several times.

This will terminate the current operation and the system will wait for further information. The user should then try to discover the source of the problem and correct it.

If no cause can be found for the error, the user should disconnect his 7670 from its communication lines and contact the appropriate service organization.

If the problem can be corrected, the method of continuing operations differs for input and output.

If output was in progress, it may be restarted by transmitting a job stream that need consist of no more than a restart command and a !FIN.

If input was in progress, the user should clear the reader of cards by pressing CARD FEED several times. If it is possible to determine the last card successfully read, the user can transmit the rest of the job stream beginning with the next card. If this cannot be determined, he should transmit the job stream beginning with the job during which the error occurred, and delete the partially transmitted job.

APPENDIX D. MULTILEAVING

Multileaving is a term that describes a computer-to-computer communication technique developed for use by the IBM HASP system. Multileaving is a protocol that is widely used in the industry and is implemented by the hardware and software of several manufacturers. The Multileaving concept is of critical importance for CP-V because any computer system that supports Multileaving can communicate with CP-V via remote processing.

Multileaving enables several streams of data to be combined into single transmission blocks so that several peripherals may be kept running at full speed. Blocks of data are formed at a remote site and sent to the central site. At the central site, they are unblocked and written into symbiont files. Similarly, transmission blocks may be formed at the central site and sent to a remote site where they must be unblocked by the hardware and software at the remote site.

Multileaving includes a data compression scheme that compresses identical strings of characters into short control sequences, thus reducing the time required for transmission.

Errors in transmission are detected by both block sequence numbering and through Cyclic Redundancy Check (CRC) computations (an elaborate yet compact multithread parity checking of all characters in a transmission block). This results in a very high degree of confidence that transmission errors will be detected. A retransmission protocol is included so that blocks in error can be retransmitted until correctly received.

Whenever communications are to be maintained but data is not available for transmission, an ACK0 character is sent periodically by both the remote site and the central site. Whenever a transmission is not received successfully, the receiving system responds with a NAK character.

When data is ready for transmission, the Multileaving software organizes it into data transmission blocks in the following manner:

1. Each physical record that is to be transmitted is organized into one or more character strings, compressing a series of three or more identical characters to a one- or two-byte character string wherever possible. Each character string is preceded by a control field, the String Control Byte (SCB).
2. Each group of character strings that represents one physical record is preceded by a control field that permits the receiving program to assign the record to the correct device. The control field is composed of a Record Control Byte (RCB) and a Subrecord Control Byte (SRCB).

3. The character string representations of the physical records and their associated control fields are preceded by two additional control fields.
 - a. The Block Control Byte (BCB), which is generally used to keep a block sequence count for detection of lost or duplicate data transmission blocks.
 - b. The Function Control Sequence (FCS), which allows the receiving system to meter the flow of individual input data streams.
4. The entire block is preceded and followed by special text control characters. Table D-1 lists the text control characters used in Multileaving.

Table D-1. Text Control Characters Used In Multileaving

Character	Hexadecimal Representation
ACK0	1070 (DLE ACK0)
DLE	10
ENQ	012D (SOH ENQ)
ETB	26
NAK	3D
PAD	FF
SOH	01
STX	02
SYNC	32

The five control characters mentioned above are described in the paragraphs that follow. A typical Multileaving transmission block is depicted in Figure D-1.

STRING CONTROL BYTE (SCB)

Input to Multileaving is in the form of physical records such as card images, print line images, or magnetic tape records. Each physical record is organized into one or more character strings by the Multileaving software. These character strings are the basic element of Multileaved transmission.

To increase transmission efficiency, records are organized into variable length character strings of two basic types.

1. A series of characters that are identical.
2. A series of characters that are not identical.

DLE	BSC Leader.
STX	BSC START-OF-TEXT.
BCB	Block Control Byte.
FCS	Function Control Sequence.
FCS	Function Control Sequence.
RCB	Record Control Byte for Record 1.
SRCB	Subrecord Control Byte for Record 1.
SCB	String Control Byte for Record 1.
DATA	Character String.
SCB	String Control Byte for Record 1.
DATA	Character String.
SCB	Terminating SCB for Record 1.
RCB	RCB for Record 2.
SRCB	SRCB for Record 2.
SCB	SCB for Record 2.
DATA	Character String.
SCB	Terminating SCB for Record 2.
RCB	Transmission Block Terminator.
DLE	BSC Leader.
ETB	BSC Ending Sequence.
CRC	Cyclic Redundancy Check.
CRC	Cyclic Redundancy Check.

Figure D-1. Typical Multileaving Data Transmission Block

Each character string is preceded by a one-byte control field called the String Control Byte (SCB). The SCB specifies the type of string and the length of the string. A character string that doesn't contain a series of identical characters is comprised of an SCB followed by the series of nonidentical characters. A character string that represents a series of three or more identical characters is compressed into two bytes – the SCB followed by the particular

character. A series of blanks is treated as a special case and consists only of one byte, the SCB. Two identical characters are not compressed; rather, they are treated as non-identical characters.

The SCB is also used to indicate the end of a record in the data transmission block. Another special use for the SCB is to indicate that a record is continued in the next data transmission block.

The format of the SCB is

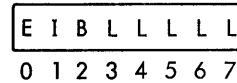

where

E has the following meanings:

If E = 0, the SCB indicates that this is the end of the record. The rest of the SCB will also be set to zero.

If E = 1 and the IBLLLLL bits are set to zero, the SCB indicates that the record is continued in the next data transmission block.

If E = 1 and at least one of the IBLLLLL bits is set to one, then the IBLLLLL bits have the meaning described below.

I indicates whether or not the string represents a series of identical characters where

0 means the string is a series of identical characters of length LLLLL.

1 means the string is a series of nonidentical characters of length BLLLLL.

B is part of the length field if I is set to one or, if I is set to 0, indicates whether or not the duplicate character is a blank. In the latter case,

0 means the duplicate character is a blank.

1 means the duplicate character is not a blank.

LLLLL is used in specifying the length of the character string.

Examples:

EBCDIC Character String	Multileaved format (in hexadecimal with SCBs underlined)
ABCD	<u>C4</u> C1C2C3C4
AAAAAAAA	<u>A9</u> C1
bbbbbb	<u>86</u>
AAAAbbbbL1,5bbbbbGG	<u>A4</u> <u>185C4D3C96BF584C2C7C7</u>

RECORD CONTROL BYTE (RCB)

The Record Control Byte (RCB) is a one-byte field used either to identify physical records within a block so that the original records can be reconstructed by the receiving software, to transmit control information, or to indicate the end of the data transmission block. The format of the RCB is

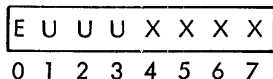

where

E indicates either that other records will follow in this data transmission block (E = 1), or that this is the end of the data transmission block (E = 0). (If E = 0, the rest of the RCB will also be set to zero.)

UUU has the following meanings when XXXX is set to zero:

001 means that permission to initiate transmission on the device whose Super-defined RCB is in the SRCB is being requested. (The SRCB is discussed below.)

010 means that permission to initiate transmission on the device whose Super-defined RCB is in the SRCB is granted.

110 means that an irrecoverable block count error occurred on a data block that was transmitted to the system sending this RCB control field.

111 means that this is a general control record and that further information is in the SRCB.

XXXX indicates that either this is a control record (XXXX = 0) with the control information being defined in UUU, or that the RCB defined with Super for the device on which this record is being output is contained in this field (XXXX ≠ 0). In the latter case, the Super-defined RCB is contained in EUUXXXX.

SUBRECORD CONTROL BYTE (SRCB)

The Subrecord Control Byte (SRCB) supplies additional information about a record or for control purposes. The format of the SRCB is

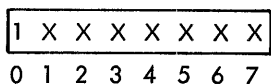

where bit 0 is always set to 1 and the meaning of the remaining bits in the SRCB depends on the type of associated RCB.

If the RCB specified that SRCB contains a Super-defined RCB, then that RCB is contained in the entire SRCB. (The bit 0 setting of 1 is valid for Super-defined RCBs.)

If the RCB specified that this is a general control record (XXXX = 0 and UUU = 110), then the SRCB supplies additional control information. Currently, the only valid SRCB setting in this case is X'C1', which indicates that the record that follows contains a /*SIGNON or IRBID command.

If the RCB contained a Super-defined RCB, then the setting of the SRCB depends on the setting of the Super-defined SRCB.

1. If the Super-defined SRCB = P, then XXXXXXXX contains VFC (vertical format control) information, where
 - 10100nnn means space nnn times before printing.
 - 1011nnnn means skip to channel nnnn before printing.
 - 10000000 means suppress space. (See the section on "Vertical Format Control".)
2. If the Super-defined SRCB = C, then bit 3 of the SRCB indicates either that this is a binary record (bit 3 = 1) or that the record is EBCDIC (bit 3 = 0).
3. If the Super-defined SRCB = U, then XXXXXXXX contains information relevant to the receiver of the record.

BLOCK CONTROL BYTE (BCB)

In each data transmission block, the Block Control Byte (BCB) is the first control field that follows the initial text control characters. Its primary purpose is to keep a block sequence count for detection of lost or duplicate transmission blocks. The format of the BCB is

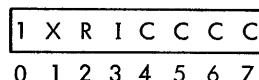

where

bit 0 is always set to one.

X is not used.

- R indicates, if set to one, that the sequence count expected by the receiving software is to be reset to the value specified by CCCC. If set to zero, the current sequence count is to be retained.
- I indicates, if set to one, that the sequence count is to be ignored. This allows a special, out-of-sequence block to be transmitted.
- CCCC specifies the block count since the beginning of transmission (modulo 16).

FUNCTION CONTROL SEQUENCE (FCS)

Each data transmission block can consist of several data streams being directed to several different output devices. Because the streams may be directed to devices of different speeds, the Function Control Sequence (FCS) control field is included to allow the receiver of a data transmission

block to meter the flow of individual data streams within the block. The format of the FCS is

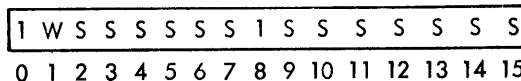

where

bits 0 and 8 are always set to one.

W specifies, if set to one, that transmission on all streams is to be suspended. The receiving software controls the setting of this bit.

S represents the individual suspend control bits, each of which is defined with the WORKSTATION command of the Super processor to correspond to a particular physical device. (Some bits may not correspond to a device and, in such case, are ignored.) If a bit is set to zero, output to its corresponding device is suspended. If a bit is set to one, output to its corresponding device is continued. The receiving software controls the setting of the suspend control bits.

APPENDIX E. OPERATING CP-V AS SLAVE IRBT TO IBM HASP SYSTEM

CP-V will act as a slave IRBT with printers, punches, a card reader and an operation console to most IBM HASP systems. To do so, several special considerations must be taken into account. The information given below is meant to aid a system manager in operating CP-V in such a mode.

SYSGEN CONSIDERATIONS

SYSGEN OPTIONS

If the DSC is used solely for the purpose of connecting to the IBM system, the WSN option in the SYSGEN :DEVICE command should be used, since it allows the line to be connected without issuing an !RBLOG key-in.

The RBX option is valuable on nonswitched lines because it allows the operator to decide when to use the link.

DEFINING THE WORKSTATION

A sample of a workstation definition for a CP-V system acting as a slave to an IBM HASP system is illustrated in Figure 4. The definition may be modified for a particular installation as follows:

1. The RMT and RWSN parameters are used to build the /* SIGNON command that CP-V will send to the HASP system to log on. This command has the form

```
/* SIGNON      REMOTEnn pppppppp
  Col.1         Col.16      Col.25
```

where nn is the remote number and pppppppp is the password assigned by the system manager of the IBM machine. These values are specified in Super for RMT (nn) and RWSN (pppppppp). Note that if RWSN is not specified, pppppppp will be blanks; if RMT is not specified, all of REMOTEⁿⁿ will be overwritten with blanks (this is the mode used in a CP-V to CP-V system).

Example:

```
RMT = 01
```

```
RWSN = SIGMACPU
```

```
/* SIGNON      REMOTE01 SIGMACPU
```

Example:

```
RMT = 1
```

```
/* SIGNON      REMOTE1
```

Example:

```
RWSN = HI
```

```
/* SIGNON      HI
```

Some IBM systems have other fields on the /* SIGNON command or use a different command entirely. When this is the case, the LOGON option can be used to specify the log-on command.

2. If the CP-V system is to appear to the HASP system to have multiple printers or punches, they should be defined like the similar device in Figure 4, with these differences:
 - The device name (DEV =) must be different.
 - The RCB should be incremented by X'10' for each additional device of the same type. (The RCB for the second punch is A5; for the third printer, B4.)
 - The RP option in the workstation definition may be used to control the priority assigned by CP-V to the printed and punched output returned from the HASP system. The specified priority is assigned to all such files.

OPERATING CONSIDERATIONS

LOGGING ON

The workstation defined above must be associated with a transmission line before the line is connected to the IBM system by connecting the phone or by keying in RBS. If the WSN option was not used when defining the line at SYSGEN, the workstation is associated with the line by means of an !RBLOG key-in. If WSN was specified, !RBLOG should never be used, because it will eliminate the SYSGENed WSN. In the following example, it is assumed that the line is RBXed, the WSN was not defined at SYSGEN, and the WSN is STA10:

```
!RBLOG RBA08,STA10
```

```
!RBS
```

```
*RBA08 CONNECTED
```

```
*RBA08-STA10-LOGGED ON
```

If the WSN was specified at SYSGEN, only the !RBS key-in is used.

The "logged on" message does not mean that communications have been established; this can best be verified by sending a command to the HASP system. If a reply is received, the systems have been properly connected. CP-V

will try to establish contact for about three minutes; if it receives no response it will disconnect the line for errors, and give the message

*RBA08 ERROR MAX

If this occurs, follow the error recovery suggestions outlined below.

SYSTEM OR LINE FAILURES

Recovery of communications after a system or line failure when communicating with HASP is complicated by the fact that HASP does not generally disconnect or restart a line automatically when line errors occur or when the remote station does not respond. Three types of failures must be handled:

- failure of the line.
- failure of the HASP system.
- failure of the CP-V system.

Line failure and HASP failure appear to the CP-V system as excessive errors or lack of response on the line. These result in a disconnect of the line, with the message

*RBnnd ERROR MAX

When this occurs, wait (in case the HASP operator is recovering his system), then key in !RBS (and !RBLOG if there was no WSN at SYSGEN). If communications are established (verify this by testing with a command), check the contact with the test described below. If another ERROR MAX occurs, contact the HASP operator and ask him to drain and restart the line. Allow time for him to do this and start the line again. If still another ERROR MAX occurs, steps to correct a telephone line failure should be taken.

If a CP-V failure occurs, the line will disconnect and reconnect after the recovery. If no WSN was defined at SYSGEN, RBX should be used to disconnect the line so that an !RBLOG key-in can be done. When a line is reconnected and logged on after a CP-V failure, the best procedure is to RBX the line, call the HASP operator to drain and restart the line, wait until this is done, then key in RBS. In some situations the call to the HASP operator is not necessary, and the two systems will reconnect so that commands can be sent to the HASP system. This may not be a good contact, hence the suggestion to call and restart.

The following test identifies a successful reconnect. Because it is open to error, it should be used only when it is difficult or impossible to contact the HASP operator to accomplish restart and reconnect:

- key in

!DISP RBT

and note whether the line is active or inactive.

- key in

!RBCOM, &RBnnd \$DLNn

to return a display from HASP of the status of the line and of each device, where n is the HASP line number (probably specified in Super as RMT). (Note that this command may have a different syntax in some HASP systems). If any of the devices are listed as active and the DISP RBT shows the line as inactive, the HASP operator should be called and the connection reestablished. If the DISP RBT shows the line as active and the HASP system shows all devices inactive, the same call should be made. Otherwise, the reconnect is successful.

APPENDIX F. ERROR LOG RECORD

This appendix contains information that is of importance to the system programmer who is involved in the development and maintenance of the CP-V system.

When an error occurs in the transmission of data to or from a remote processing workstation, the error log record described below is entered in the ERRFILE file. (The ERRFILE file is described in detail in the CP-V/SP Reference Manual, 90 31 13.)

word 0

Type X'26'	Length X'08'	I/O address
0 1 2 3 4 5 6 7	8 9 10 11 12 13 14 15 16 17	18 19 20 21 22 23 24 25 26 27 28 29 30 31

word 1

Relative time
0 1 2 3 4 5 6 7 8 9 10 11 12 13 14 15 16 17 18 19 20 21 22 23 24 25 26 27 28 29 30 31

word 2

RB:FLAGS
0 1 2 3 4 5 6 7 8 9 10 11 12 13 14 15 16 17 18 19 20 21 22 23 24 25 26 27 28 29 30 31

words 3 and 4

Workstation name
0 1 2 3 4 5 6 7 8 9 10 11 12 13 14 15 16 17 18 19 20 21 22 23 24 25 26 27 28 29 30 31

words 5 and 6

Current command doubleword
0 1 2 3 4 5 6 7 8 9 10 11 12 13 14 15 16 17 18 19 20 21 22 23 24 25 26 27 28 29 30 31

word 7

RP1	RP2	RP3	RP4
0 1 2 3 4 5 6 7	8 9 10 11 12 13 14 15 16 17 18 19 20 21 22 23 24 25 26 27 28 29 30 31		

where

type identifies the type of error log record.

length specifies the number of 32-bit words contained in the error log record.

I/O address is a 16-bit address representing the physical I/O address.

relative time represents milliseconds since midnight. Resolution is 2 msec.

RB:FLAGS specifies the contents of RB:FLAG at the time of the error. RB:FLAG is described in the CP-V/Data Base Technical Manual, 90 19 95.

workstation name specifies the workstation name (in TEXT format, left-justified and padded with blanks) if the terminal is logged on.

current command doubleword specifies the command doubleword of the I/O that was taking place when the error occurred. For Xerox 7670 RBTs, the current command doubleword contains the second command doubleword used to write the text of an output message and is meaningful only for RP1 = 0, 1, A, or B.

RP1, RP2, RP3, and RP4 have specific meaning for the type of remote workstation associated with the record. The meanings are listed in Tables F1-F6.

Table F-1. Xerox 7670 RBT - RP1, RP3, RP4

RP1 Value	Meaning	Corresponding RP3 Meaning	Corresponding RP4 Meaning
1	First character in record not SOH.	Current character position.	Offending character.
2	Incorrect parity on SEL.	Current character position.	Offending character.
3	Incorrect block protect.	Current character position.	Offending character.
4	Third character in record not STX.	Current character position.	Offending character.
5	RBBAT combuf or MPOOL unavailable for log-on.	Meaningless.	Meaningless.

Table F-1. Xerox 7670 RBT - RP1, RP3, RP4 (cont.)

RP1 Value	Meaning	Corresponding RP3 Meaning	Corresponding RP4 Meaning
6	Incorrect character parity.	Current character position.	Offending character.
7	Record trailer character not ETX.	Current character position.	Offending character.
8	Incorrect block check parity.	Current character position.	Offending character.
9	Incorrect block check.	Current character position.	Offending character.
A	Communication line time-out.	Meaningless.	Meaningless.
B	NAK received.	Response received reading for ACK.(RP3 and RP4 combine to be a halfword).	
C	Garbled ACK or NAK.	Response received reading for ACK.(RP3 and RP4 combine to be a halfword).	

Table F-2. Xerox 7670 RBT - RP2

RP2 Value	Meaning (Current Function Code)
0	Write card punch.
1	Write line printer.
2	Send ACK.
3	Write TOF (Block protect=0).
4	Write TOF (Block protect=1).
5	Write SPACE (Block protect=0).
6	Write SPACE (Block protect=1).
7	Read card reader.
8	Write TOF (logon).
9	Read card reader (special).
A	Read ACK card punch.
B	Read ACK line printer.
C	Read ACK TOF (Block protect=0).
D	Read ACK TOF (Block protect=1).
E	Read ACK SPACE (Block protect=0).
F	Read ACK SPACE (Block protect=1).
10	Write EOT.
11	Write DC1.
12	Write ACK (special).
13	Write NAK.
14	Write NAK (special).
15	Write BEL (on error).

Table F-3. IBM 2780 RBT - RP1 and RP4

RP1 Value	Meaning	Corresponding RP4 Meaning
1	Disconnect due to a. EOT on read. b. Use of 2780 on IRBT only system.	EOT ENQ
2	Line timeout.	Same as RP2.
3	ENQ not received on logon read.	Character received.
4	No EOT after EOF sent.	Character received.
5	a. ENQ in text mode. b. No ENQ answering WACK. c. ENQ answer to ACK of EOF.	Character received. Character received. Character received.
6	NAK received.	Character received.
8	CRC failed on input.	Last character CRcd.
9	Unknown response reading for ACK.	Character received.
A	Trailer character not ETB or ETX.	Character received.
C	Header character not STX.	Character received.

Table F-4. IBM 2780 RBT – RP2 and RP3

Value	RP2 (Current Function Code)	RP3 (Calling Function Code)
0	Disconnect.	Software error – should not occur.
1	Write data.	Write.
2	Send ENQ.	Send ENQ (Wait).
3	Send ACK O.	Read.
4	Send WACK.	Send WACK (Wait).
5	Write data.	Write EOF.
6	Send ENQ.	Request to output.
7	Read for ACK, ENQ, EOT (depends on RP3).	POL for input.
8	Read for ENQ.	Logon.
9	Read.	Software error – should not occur.
A	Send NAK.	Software error – should not occur.
B	Send ACK I.	Software error – should not occur.
C	Send EOT.	Software error – should not occur.

Table F-5. IRBT – RP1 and RP4

RP1 Value	Meaning	Corresponding RP4 Meaning
0	Recoverable block check error.	Difference (mod 16) between expected and received BCBs.
1	Catastrophic block check error (NAK sent in case of line error).	Difference (mod 16) between expected and received BCBs.
2	Communication line time-out.	Same as RP2.
3	Read for ENQ timed-out (logon).	Same as RP2.
4	Received ACK O instead of SIGNON at logon.	ACK O
5	Inappropriate line bid (not ENQ-master, not ACK O-slave).	Line bid received.
6	NAK received.	NAK.
7	Read timed out.	Same as RP2.
8	Incorrect CRC.	Last character CRCed.
9	Trailer character not ETB.	Offending character.
A	Leader character not STX.	Offending character.
B	Lost data.	First character after DLE.
C	Garbled ACK O-NAK.	First character of message.

Table F-6. IRBT – RP2 and RP3

Value	RP2 (Current Function Code)	RP3 (Calling Function Code)
0	Disconnect.	Software error – should not occur.
1	Write block.	Write block – read block.
2	Write ACK.	Write ACK – read block.
3	Write block.	Write block (Wait-a-bit) – Read special.
4	Write Wait-a-bit.	Write Wait-a-bit – Read special.
5	Read block.	Software error – should not occur.
6	Send NAK.	Software error – should not occur. [†]
7	Send ENQ.	Logon as Slave.
8	Read for ENQ.	Logon as Master.
9	ACK O to ENQ.	Logon as Master after ENQ Read.
A	Read logon record.	Software error – should not occur.
B	NAK logon record.	Software error – should not occur. [†]

[†] If errors with the same RP1 code occur consecutively, this code may appear in the RP3 field for the second and subsequent consecutive errors, replacing another legal RP3 code.

INDEX

Note: For each entry in this index, the number of the most significant page is listed first. Any pages thereafter are listed in numerical sequence.

2780 RBT, 2, 16
 operation of, 43
3780 RBT, 2, 16
7670 RBT, 1, 15

B

batch job, vii

C

central site operator, 25
connecting remote site and central site telephone lines, 41
control commands,
 JOB, 11
 LDEV, 5
 RBABORT, 20
 RBALIGN, 20
 RBCONTINUE, 19
 RBCTL, 20
 RBDELETE, 18
 RBDEV, 17
 RBDISC, 17
 RBFORM, 20
 RBHOLD, 18
 RBID, 17
 RBINFO, 18
 RBLOCK, 20
 RBMSG, 17
 RBPRIOR, 18
 RBREPRINT, 19
 RBRETRIEVE, 18
 RBSAVE, 20
 RBSIZE, 20
 RBSTATUS, 19
 RBSUSPEND, 19
 RBSWITCH, 19
 RBUNLOCK, 20
 RBXXX, 17

D

data set controller, 3
DELETE command, ISCL, 13
:DEVICE command, 27
DISPLAY key-in, 25
DSC, 3

E

EM character, vii
error log record, 55

F

:FECF command, 27
file,
 held, vii
 noncontrol input, 21, 8
 remote management, 12
 suspended, vii
forms, changing, 21

G

ghost job, vii

H

hardware connection of remote terminals, 2
HASP, 2, 49
held file, vii

I

IBM HASP Multileaving protocol, 49, 2
IBM HASP system, 53
Intelligent Remote Terminal (see IRBT)
IRBT, 1, 2, 15
 operation of, 43
ISCL processor, 12
 commands, 12
 DELETE, 13
 LIST, 13
 SEND, 13
 error messages, 14, 24

J

JOB command, 11
job stream, vii

K

keyins,
 DISPLAY, 25
 RBBDCST, 25
 RBCOM, 25
 RBDISC, 25
 RBLOG, 25
 RBS, 25
 RBSEND, 25
 RBSWITCH, 26
 RBX, 26

Note: For each entry in this index, the number of the most significant page is listed first. Any pages thereafter are listed in numerical sequence.

L

LDEV command, 5
LDEV processor, 10
LIST command, ISCL, 13
local users, 5
logical device stream, 5, vii

M

master system, 2
message file, vii
messages to central site operator, 26
messages to remote processing users, 21
:MON command, 27
Multileaving, 49, 2

N

!!NCTL command, 21, 8
noncontrol input files, 21, 8

O

on-line job, vii
operator key-ins, 25
operator, central site, 25
operator, remote, 17

P

protocol, vii

R

RATLER processor, 12
 messages, 24
RBABORT command, 20
RBALIGN command, 20
RBBDCST key-in, 25
RBCC, vii
RBCOM key-in, 25
RBCONTINUE command, 19
RBCTL command, 20
RBDELETE command, 18
RBDEV command, 17
RBDISC command, 17
RBDISC key-in, 25
RBFORM command, 20
RBHOLD command, 18
RBID command, 17
RBINFO command, 18
RBLOCK command, 20
RBLOG key-in, 25

RBMSG command, 17
RBPRIOR command, 18
RBREPRINT command, 19
RBRETRIEVE command, 18
RBS key-in, 25
RBSAVE command, 20
RBCEND key-in, 25
RBSIZE command, 20
RBSTATUS command, 19
RBSUSPEND command, 19
RBSWITCH command, 19
RBSWITCH key-in, 26
RBT, 1
 2780, 2, 16
 3780, 2, 16
 7670, 1, 15
 operation of, 45
RBUNLOCK command, 20
RBX key-in, 26
RBXXX command, 17
record size restrictions, 14
Remote Batch Terminal (see RBT)
remote control command, vii
remote operator, 17
remote processing, 1
 control commands, 17
 establishing at SYSGEN, 27
 hardware, 3
 messages, 21
 modes, 2
remote site, vii
remote terminals, 1
remote user, 5, vii

S

scope of the manual, 4
:SDEVICE command, 27
SEND command, ISCL, 13
short block control character, vii
slave system, 2
Super, 28
 WORKSTATION command, 29
 X command, 40
suspended file, vii
symbiont, vii
symbiont retry point, vii
SYSGEN, 27
 :DEVICE command, 27
 :FECF command, 27
 :MON command, 27
 :SDEVICE command, 27
sysid, vii
system manager, 27

T

telephone lines, connecting remote sites, 41

Note: For each entry in this index, the number of the most significant page is listed first. Any pages thereafter are listed in numerical sequence.

V

vertical format control at remote printers, 15

WORKSTATION command, Super, 29

WS, 3

WSN, 4

W

workstation, 3

defining, 28

X

X command, Super, 40

Honeywell Information Systems
In the U.S.A.: 200 Smith Street, MS 486, Waltham, Massachusetts 02154
In Canada: 2025 Sheppard Avenue East, Willowdale, Ontario M2J 1W5
In Mexico: Avenida Nuevo Leon 250, Mexico 11, D.F.

16366, 2.5C876, Printed in U.S.A.

XP94, Rev. 0